



Vacanza[®] Series.

2025 OWNER'S MANUAL



WELCOME



Watkins Wellness® congratulates you on your decision to enjoy the finest spa available... Welcome to the growing family of Caldera® Spa owners.

Owner's Manual

This Owner's Manual will acquaint you with the operation and general maintenance of your new Vacanza® series spa. We suggest that you take some time to carefully review all sections. Please keep this manual available for reference.

If you have any questions about any aspect of your spa's set-up, operation or maintenance, contact your authorized **CALDERA** dealership. They are trained professionals who are familiar with the product as well as new spa ownership concerns. Their expertise will facilitate the enjoyment of your new **CALDERA** spa.

The serial number/identification label is located within the equipment compartment of your **CALDERA** spa. The serial number should also be documented on the delivery receipt from your dealer.

IMPORTANT: Watkins Wellness reserves the right to change specifications, or design, without notification and without incurring any obligation.

DATE PURCHASED: _____

DATE INSTALLED: _____

DEALER: _____

ADDRESS: _____

TELEPHONE: _____

SPA MODEL/SERIAL NUMBER: _____

COVER SERIAL NUMBER: _____

MODEL: PALATINO
SERIES: VACANZA
SERIAL: PLT25D119XXXX
RATINGS: 240V, 60Hz, 40A



LISTED SELF CONTAINED SPA
1280 Park Center Dr., Vista, CA 92081
Watkins Manufacturing Corp.

PLT25D119XXXX
PLT25D119XXXX
PLT25D119XXXX
PLT25D119XXXX
PLT25D119XXXX

NOTE: This is an example. Your spa's label will contain different information. Peel off top sticker and place here.

In most cities and counties, permits will be required for the installation of electrical circuits or the construction of exterior surfaces (decks and gazebos). In addition, some communities have adopted residential barrier codes which may require fencing and/or self-closing gates on the property to prevent unsupervised access to a pool (or spa) by children under 5 years of age. Your **CALDERA** spa is equipped with a locking cover that meets the ASTM F1346-91 Standard for Safety Covers, and as a result, is usually exempt from most barrier requirements. As a general practice, your local Building Department will inform you of any applicable barrier requirements at the time a permit is obtained for the installation of an electrical circuit. Your **CALDERA** dealer can provide information on which permits may be required.

TABLE OF CONTENTS

SAFETY INFORMATION

IMPORTANT SAFETY INSTRUCTIONS	1
IMPORTANT SPA INSTRUCTIONS.....	3

ELECTRICAL REQUIREMENTS

ELECTRICAL REQUIREMENTS	4
230 VOLT 50A WIRING INSTRUCTIONS	4
GFCI.....	5
115 VOLT INSTALLATION.....	5
115-230 VOLT CONVERSION (TARINO® , CELIO™ & AVENTINE® MODELS).....	5

GETTING STARTED

SPA FEATURES PALATINO®, MARINO®, VANTO® TARINO & CELIO MODELS	7
SPA FEATURES AVENTINE MODEL	8
HYDRO JETS.....	9
DIVERTER VALVE (TARINO MODEL ONLY)	9
QUICK START-UP INSTRUCTIONS	9
START-UP	10
EQUIPMENT COMPARTMENT	11

OPERATING INSTRUCTIONS

CONTROL OPERATION.....	12
SYSTEM MODE	12
CLEANING MODE.....	13
TOOLS MENU.....	13
FRESHWATER SALT SYSTEM	14
AUDIO MENU (OPTIONAL).....	15

JET MENUS

PALATINO	17
MARINO	17
VANTO	18
TARINO.....	18
CELIO & AVENTINE	19

WATER QUALITY AND MAINTENANCE

BASIC INFORMATION.....	20
HOW TO ADD CHEMICALS TO THE WATER	20
FUNDAMENTALS OF WATER MAINTENANCE.....	21
THE CALDERA SPA WATER MAINTENANCE PROGRAM.....	22
VANISHING ACT INSTRUCTIONS.....	23
VACATION WATER CARE INSTRUCTIONS.....	24
WATER TERMINOLOGY	25

SPA CARE AND MAINTENANCE

DRAIN & REFILL INSTRUCTIONS.....	26
PREVENTION OF FREEZING	26
WINTERIZING YOUR SPA.....	26
FILTER SYSTEM	27
FILTER CARTRIDGES REMOVAL & CLEANING FOR ALL MODELS EXCEPT AVENTINE	27
FILTER CARTRIDGES REMOVAL & CLEANING FOR AVENTINE MODEL.....	27
CARE OF THE SPA PILLOWS	28
CARE OF THE EXTERIOR.....	28
CARE OF THE ECOTECH CABINET	28
CARE OF THE SPA COVER	28

SERVICE INFORMATION

GENERAL INFORMATION	29
GFCI AND HIGH LIMIT THERMOSTAT	29
MISCELLANEOUS SERVICE INFORMATION.....	29
ACTS INVALIDATING WARRANTY	30
DISCLAIMERS.....	30
WATKINS CUSTOMER SERVICE	30
TROUBLESHOOTING	30
DOOR PANEL INSTRUCTIONS	31
SPA SPECIFICATIONS	32

SAFETY INFORMATION

IMPORTANT SAFETY INSTRUCTIONS

(READ AND FOLLOW ALL INSTRUCTIONS)

AVOIDING THE RISK TO CHILDREN

DANGER - RISK OF CHILD DROWNING

Extreme caution must be exercised to prevent unauthorized access by children. To avoid accidents, ensure that children cannot use a spa unless they are supervised at all times.

WARNING

To reduce the risk of injury, do not permit children to use this spa unless they are closely supervised at all times.

- To reduce the risk of injury, lower water temperatures are recommended for young children. Children are especially sensitive to hot water.
- Extreme caution must be exercised to prevent unauthorized access by children. To avoid accidents, ensure that children cannot use a spa unless they are supervised at all times.

DO:

- Make sure you always lock the child resistant locks after using the spa for your children's safety. Every CALDERA spa is equipped with a locking cover that meets the ASTM F1346-91 Standard for Safety Covers.
- Test the water temperature with your hand before allowing children to enter the spa to be sure that it's comfortable. Children are especially sensitive to hot water.
- Remind children that wet surfaces can be very slippery. Make sure that children are careful when entering or exiting the spa.

DON'T:

- Allow children to climb onto the spa cover.
- Allow children to have unsupervised access to the spa.

AVOIDING THE RISK OF ELECTROCUTION

DANGER - RISK OF ELECTROCUTION

- Connect only to a grounded source.
- Do not bury the power cord. A buried power cord may result in death, or serious personal injury due to electrocution if direct burial-type cable is not used, or if improper digging occurs.
- A ground terminal (pressure wire connector) is provided on the control box inside the unit to permit connection of a minimum No. 8 AWG solid copper bonding conductor between this point and any metal equipment, metal water pipe, metal enclosures of electrical equipment, or conduit within 5 feet (1.5 m) of the unit as needed to comply with local requirements.

- Do not operate the audio main controls while inside the spa (if spa is equipped with an audio component).
- Do not connect any auxiliary components (for example, cable additional speakers, headphones, additional audio components) to the audio system unless approved by Watkins Wellness .
- Do not self service audio component by opening spa door as this may expose dangerous voltage or other risk of injury. Refer all servicing to qualified service personnel.
- Do not attach an external antennae to a spa audio system unless installed by a licensed electrician in accordance with Article 810 of the National Electric Code, ANSI/NFPA 70.

WARNING

- To reduce the risk of electrical shock, replace a damaged cord immediately. Failure to do so may result in death or serious personal injury due to electrocution.
 - Your spa is provided with a Ground Fault Circuit Interrupter (GFCI) for user and equipment protection. To ensure proper operation of this important safety device, test according to the following instructions per electrical configuration.
 - **Cord-Connected 115 volt, 20 amp models:** The GFCI is located at the end of the power cord. Before each use, with the unit operating, push the TEST button. The unit should stop operating and the GFCI power indicator will go out. Wait 30 seconds and then reset the GFCI by pushing the RESET button. The GFCI power indicator will turn on, restoring power to the spa. If the interrupter does not perform in this manner, there may be an electrical malfunction and with it, the possibility of an electric shock. Disconnect the power until the problem has been corrected.
 - **230 volt permanently installed or converted models:**
 - A ground terminal is provided on the terminal block (TB-1, system ground terminal) located inside the control box. To reduce the risk of electric shock, connect this terminal to the grounding terminal of your electrical service or supply panel with a continuous green, insulated copper wire. The wire must be equivalent in size to the circuit conductors supplying the equipment. In addition, a bonding terminal (pressure wire connector) is provided on the outside of the control box for bonding to local ground points. To reduce the risk of electric shock, this connector should be bonded with a No. 8 AWG solid copper wire to any metal ladders, water pipes, or other metal within 5 feet (1.5 m) of the spa to comply with local requirements. The means of disconnection must be readily accessible, but must be installed at least 5 feet (1.5 m) from the spa.
 - Your spa is provided with a suitably rated circuit breaker to open all ungrounded supply conductors.
 - Your spa uses ground fault circuit interrupters in the electrical subpanel. Before each use of the spa and with the unit operating, push the TEST button on each breaker. The switch should click over to the "Trip" position. Wait 30 seconds and reset each GFCI breaker by switching it completely off and then completely on. The switch should then stay on. If either of the interrupters does not perform in this manner, it is an indication of an electrical malfunction and the possibility of an electric shock. Disconnect the power until the fault has been identified and corrected.
- IMPORTANT:** Failure to wait 30 seconds before resetting the GFCI may cause the spa's Power Indicator (on the control panel) to blink. If this occurs, repeat the GFCI test procedure.

DANGER - RISK OF ELECTRICAL SHOCK

- Install at least 5 feet (1.5 m) from all metal surfaces. A spa may be installed within 5 feet (1.5 m) of a metal surface if each metal surface is permanently connected by a minimum No. 8 AWG solid copper conductor attached to the wire ground connector on the terminal box that is provided for this purpose if in accordance with National Electrical Code ANSI/NMFA70-1993.
- Do not permit any electrical appliances, such as a light, telephone, radio, or television within 5 feet (1.5 m) of a spa. Failure to maintain a safe distance may result in death, or serious personal injury due to electrocution, if the appliance should fall into the spa.
- Install your spa in such a way that drainage is away from the electrical compartment and from all electrical components.

DO:

- Be sure your spa is connected to the power supply correctly - use a licensed electrical contractor.
- Disconnect the spa from the power supply before draining the spa or servicing the electrical components.
- Test the Ground Fault Circuit Interrupter before each use.
- Replace audio components only with identical components (if your spa is equipped with an audio component).

DON'T:

- Use the spa with the equipment compartment door removed.
- Place electrical appliances within 5 feet (1.5m) of the spa.
- Use an extension cord to connect the spa to its power source. The cord may not be properly grounded and the connection is a shock hazard. An extension cord may cause a voltage drop, which will cause overheating of the jet pump motor and motor damage.
- Attempt to open the electrical control box. There are no user serviceable parts inside.

RISKS TO AVOID

DANGER - RISK OF INJURY

- To reduce the risk of injury to persons, DO NOT remove suction fittings (filter standpipes) located in the filter compartment.
- The suction fittings in the spa are sized to match the specific water flow created by the pump. Never replace a suction fitting with one rated less than the flow rate marked on the original suction fitting.
- There is a danger of slipping and falling. Remember that wet surfaces can be very slippery. Take care when entering or exiting the spa.
- Never operate spa if the suction fittings are broken or missing.
- People with infectious diseases should not use the spa.
- Keep any loose articles of clothing, long hair, or hanging jewelry away from rotating jets or other moving components.

INCREASED SIDE EFFECTS OF MEDICATION

- The use of drugs, alcohol may cause unconsciousness with the possibility of drowning.
- Persons using medications should consult a physician before using a spa; some medication may cause a user to become drowsy, while other medication may affect heart rate, blood pressure, and circulation.

- Persons taking medications which induce drowsiness, such as tranquilizers, antihistamines, or anticoagulants should not use the spa.

HEALTH PROBLEMS AFFECTED BY SPA USE

- Pregnant women should consult a physician before using spa.
- Persons suffering from obesity, or with a medical history of heart disease, low or high blood pressure, circulatory system problems, or diabetes should consult a physician before using spa.

UNCLEAN WATER

- Keep the water clean and sanitized with correct chemical care. The recommended levels for your **CALDERA** spa are:

Free Available Chlorine: 3.0-5.0 ppm	Total Alkalinity: 40-120 ppm
Water pH: 7.2-7.8	Calcium Hardness: 75-150 ppm

- Refer to Water Quality and Maintenance section for complete instructions.

IMPORTANT: Turn on the jet pump for a least ten minutes after adding ANY spa water chemicals into the filter compartment.

Clean the filter cartridges monthly to remove debris and mineral buildup which may affect the performance of the hydromassage jets, limit the flow, or trip the high limit thermostat, which will turn off the entire spa.

AVOIDING THE RISK OF HYPERTHERMIA

Prolonged immersion in hot water can result in HYPERTHERMIA, a dangerous condition which occurs when the internal temperature of the body reaches a level above normal 98.6°F (37°C). The symptoms of hyperthermia include unawareness of impending hazard, failure to perceive heat, failure to recognize the need to exit the spa, physical inability to exit the spa, fetal damage in pregnant women, and unconsciousness resulting in a danger of drowning.

WARNING

The use of alcohol, drugs, or medication can greatly increase the risk of fatal hyperthermia in hot tubs and spas.

TO REDUCE THE RISK OF INJURY

- The water in the spa should never exceed 104°F (40°C). Water temperatures between 100°F and 104°F (36°C and 40°C) are considered safe for a healthy adult. Lower water temperatures are recommended for extended use (exceeding ten minutes) and for young children. Extended use can cause hyperthermia.
- Pregnant or possibly pregnant women should limit spa water temperatures to 100°F (36°C). Failure to do so may result in permanent injury to your baby.
- Do not use spa immediately following strenuous exercise.

AVOIDING THE RISK OF SKIN BURNS

- To reduce the risk of injury, before entering a spa the user should measure the water temperature with an accurate thermometer.
- Test the water with your hand before entering the spa to be sure it's comfortable.

SAFETY SIGN

Each **CALDERA** spa is shipped with a SAFETY SIGN in the owner's package. The sign, which is required as a condition of Product Listing, should be permanently installed where it is visible to the users of the spa. To obtain additional SAFETY SIGNS, contact your **CALDERA** dealer and request Part #70798.

IMPORTANT SPA INSTRUCTIONS

The following contains important spa information, and we strongly encourage you to read and apply them.

DO:

- Use and lock the vinyl cover when the spa is not in use, whether it is empty or full.
- Follow the Spa Care and Maintenance recommendations stated in this manual.
- Use only approved accessories and recommended spa chemicals and cleaners.

DON'T

- Leave the **CALDERA** spa exposed to the sun without water or the cover in place. Exposure to direct sunlight can cause solar distress of the shell material.
- Roll or slide the spa on its side. This will damage the siding.
- Lift or drag the vinyl cover by using the cover lock straps; always lift or carry the cover by using the handles.
- Attempt to open the electrical control box. There are no user serviceable parts inside. Opening of the control box by the spa owner will void the warranty. If you have an operational problem, carefully go through the steps outlined in the Troubleshooting section. If you are not able to resolve the problem, contact your authorized **CALDERA** dealer. Many problems can easily be diagnosed over the telephone by an Authorized Service Technician.

SPA SHELL

Your **CALDERA** spa has an acrylic shell. Stains and dirt generally will not adhere to your spa's surface. A soft rag should easily remove most dirt. Most household chemicals are harmful to your spa's shell (see below for detailed information on cleaning agents). Always rinse off any spa shell cleaning agent with fresh water.

IMPORTANT:

1. The following products are the **ONLY** approved cleaning agents for your **CALDERA** spa shell: plain water, **CALDERA**® Spa Shine, or Soft Scrub®. The use of alcohol or any other household cleaner other than those listed to clean the spa shell surface is **NOT** recommended. **DO NOT** use any cleaning products containing abrasives or solvents since they may damage the shell surface, specifically: Simple Green®, Windex® or Spa Mitt. **NEVER USE HARSH CHEMICALS!** Damage to the shell by use of harsh chemicals is not covered under the warranty. Always rinse off any spa shell cleaning agent with fresh water.
2. Iron and copper in the water can stain the spa shell if allowed to go unchecked. Ask your **CALDERA** dealer about a Stain and Scale Inhibitor to use if your spa has a high concentration of dissolved minerals. (Watkins recommends Stain & Scale Defense.)
3. Keep all cleaners out of the reach of children and use care when applying.

SAVE THESE INSTRUCTIONS

ELECTRICAL REQUIREMENTS

IMPORTANT: Fill the spa with water before turning on the power.

Your **CALDERA** spa has been carefully designed to give you maximum safety against electrical shock. Connecting the spa to an improperly wired circuit will negate many of the spa's safety features. Improper wiring may also cause electrocution, risk of fire, and other risks of injuries. Please read and follow the electrical installation requirements and instructions for your specific spa model completely!

- The **TARINO, CELIO** and **AVENTINE** operate on 115 volts 20 amp 60 Hz. These models can also be converted to 230 volt 50 amp.

When they are connected to 115 volts 20 amp, the heater will provide approximately 1000 watts of heat, only when the thermostat is calling for heat. When these spas are connected to 230 volts 50 amps, the heater will provide approximately 4000 watts of heat when the thermostat is calling for heat.

- The **PALATINO, MARINO & VANTO** models require a dedicated 230 volt power supply.

230 VOLT PERMANENTLY CONNECTED MODELS

(**PALATINO, MARINO & VANTO** only)

CALDERA spas must be wired in accordance with all applicable local electrical codes. All electrical work should be done by an experienced, licensed electrician. We recommend the use of appropriate electrical conduit, fittings, and wire for all circuits.

The diagram below illustrates how to wire 230 volt permanently connected spa models:

- An electrical subpanel containing a GFCI breaker is included with each 230 volt spa. We recommend that this subpanel be used to supply power to the spa.
- The subpanel requires a 50 amp, single phase, 230 volt, four wire service (two line, one neutral, one ground). The grounding conductor must not be less than #10 AWG. Refer to local codes and to NEC 250-122 table.
- Mount the subpanel in the vicinity of the spa, but not closer than five feet away, in accordance with all local codes. (N.E.C. 680-38 to 41-A-3)

Once your spa has been filled with water, turn it on and test all of the circuit breakers.

IMPORTANT: If the breaker immediately trips, verify that the wires are correctly connected. The breaker should be tested prior to each use. Here's how:

1. Push the "TEST" button on the GFCI breaker, and observe it click OFF.
2. Wait 30 seconds, then push the breaker switch to the OFF (down) position (to ensure that it has completely disengaged), then push the breaker switch to the ON (up) position. If you don't wait 30 seconds, the spa's power indicator may continue to blink – try again.

If the GFCI breaker fails to operate in this manner, your spa may have an electrical malfunction, and you may be at risk of electrical shock. Turn off all circuits and do not use the spa until the problem has been corrected by an authorized service agent.

⚠ WARNING: Removing, or bypassing any GFCI breaker will result in an unsafe spa and will void the spa's warranty.

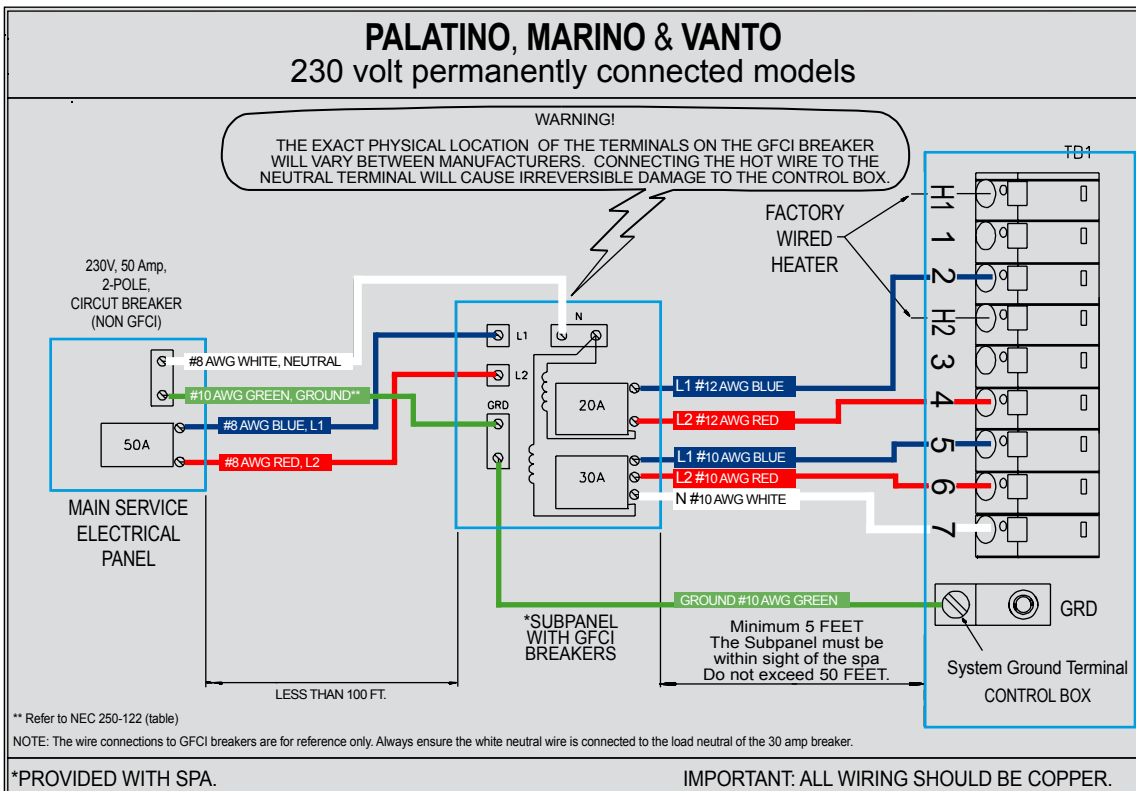

GFCI TARINO, CELIO and AVENTINE

The Ground Fault Circuit Interrupter (GFCI) is a safety device that is designed to detect as little as 5 milliamps ($\pm 1\text{mA}$) of electrical current leakage to ground. **WATKINS WELLNESS** recommends that the GFCI be tested prior to each use to ensure it is functioning correctly. With the spa connected to the power supply, push the "Test" button. The spa should stop operating and the GFCI power indicator will go out. Wait 30 seconds and then reset the GFCI by pushing the Reset button. The GFCI power indicator will turn on, restoring power to the spa. If the interrupter does not perform in this manner, it is an indication of an electrical malfunction and the possibility of an electric shock. Disconnect the plug from the receptacle until the fault has been identified and corrected.

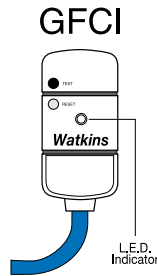

IMPORTANT: Never use the GFCI as a means to disconnect power to the spa (always unplug it). If the GFCI is tripped while the spa is plugged in, and a power outage occurs, when power returns the GFCI will automatically reset and power will flow to the spa.

115 VOLT OPERATION (60Hz ONLY)

The spa must be connected to a dedicated 115 volt, 20 amp, GFCI protected, grounded circuit. The term "dedicated" means the electrical circuit is not being used or shared for any other electrical items (patio lights, appliances, garage circuits, etc.). If the spa is connected to a non-dedicated circuit, overloading will result in "nuisance tripping" at the main panel. This requires frequent resetting of the breaker switch at the house electrical breaker panel and introduces the possibility of damage or failure of spa equipment.

NEVER CONNECT THE SPA TO AN EXTENSION CORD!

A pressure wire connector is provided on the exterior surface of the control box, inside the spa. This is to permit the connection of a ground bonding wire between this point and any metal equipment, enclosures, reinforced concrete pad, pipe, or conduit within 5 feet (1.5 m) of the spa (if needed to comply with local building code requirements). The bonding wire must be at least a #10-AWG solid copper wire.

Bond the spa to all exposed metal equipment or fixtures, handrails, and concrete pad per N.E.C. Article 680 and all local codes.

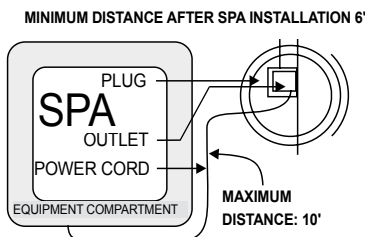

INSTALLATION INSTRUCTIONS

All 115 volt spa models come equipped with approximately 15 feet (15 m) of useable power cord (this is the maximum length allowed by Underwriters Laboratory and the National Electric Code). When the spa is installed, the power cord will come out of the bottom of the equipment compartment door. For your safety, when the electrician is installing the single electrical outlet and waterproof cover, the outlet should be no closer than 5 feet (1.5 meters) and no farther than 10 feet from the spa [reference National Electrical Codes].

The Ground Fault Circuit Interrupter (GFCI) is located at the end of the

power cord. This device is for your protection. It is very important to protect it from rain and other moisture. Test once a month, with the plug connected to the power supply,

1. Push the "TEST" button on the GFCI breaker. The spa should stop operating and the GFCI power indicator will go out.
2. Wait 30 seconds, then push the "RESET" button. Power will be restored to the spa and the GFCI power indicator will turn on.

If the GFCI fails to operate in this manner, your spa may have an electrical malfunction, and you may be risking electrical shock. Turn off all circuits and do not use the spa until the problem has been corrected by an authorized service agent.

⚠ WARNING: Removal of the GFCI from the spa's power cord will result in an unsafe spa and will void the spa's warranty.

IMPORTANT: Should you ever find the need to move or relocate your **HOT SPRING** spa, it is essential that you understand and apply these installation requirements. Your **HOT SPRING** spa has been carefully engineered to provide maximum safety against electric shock. Remember, connecting the spa to an improperly wired circuit will negate many of its safety features.

ADVANTAGE TO HAVING YOUR SPA CONVERTED

- In the 115 volt configuration, either the heater, or the jet pump can operate, but they can't work at the same time. In a 115 volt system, as long as the jet pump is activated, the heater will not turn on. On the other hand, when the spa is converted to operate in the 230 volt configuration, the heater and jet pump can operate simultaneously.
- The heater will operate at 1000 watts when the spa is configured as a 115 volt cord-and-plug connected model, and at 4000 watts when the spa is configured as a 230 volt converted model heating your spa water faster.

115/230 VOLT CONVERTIBLE MODELS

The **TARINO, CELIO** and **AVENTINE** models can be converted to 230 volt operation with the addition of a subpanel and a control box wiring change. Consult your dealer before attempting to convert from 115 volt operation to 230 volt operation. Any damage to the spa from improper conversion is not covered under the warranty.

230 VOLT CONVERSION

CALDERA spas must be wired in accordance with all applicable local electrical codes. All electrical work should be done by an experienced, licensed electrician. We recommend the use of appropriate electrical conduit, fittings, and wire for all circuits.

Refer to the following instructions to convert from 115 volt to 230 volt

IMPORTANT: Converting the spa to 230 volt operation will require both an authorized **CALDERA** service agent and a qualified electrician.

Required Part: A 50A Subpanel with 20A & 30A breakers (for 230 volt Convertable) available from your **CALDERA** dealer.

1. Disconnect the power cord from the house receptacle.
2. Open the equipment compartment door.
3. Remove the screws on the front of the spa control box.
4. Open the control box cover.
5. Identify Terminal block located in the lower left-hand corner inside the control box.

1. Refer to illustration, Step 1. Remove the 2 pin jumper attached to terminals 4 and 5.
2. Refer to illustration, Step 1. Remove the wire jumper from terminals 2, and 6.
3. Refer to illustration, Step 2. Remove the power cord wires from 5, 7 and GRD (not illustrated).
4. Unscrew the power cord strain relief and remove the power cord from the access hole in the control box.

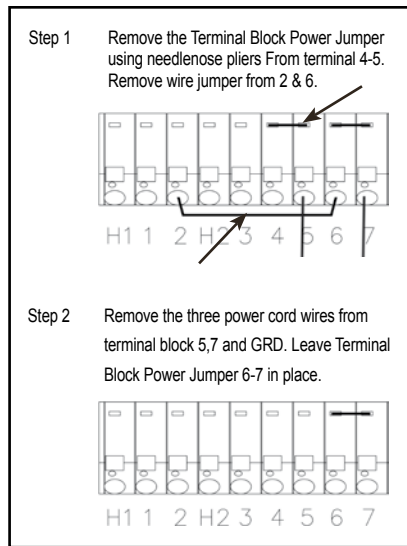

WIRING CONNECTIONS

IMPORTANT: Fill the spa with water before turning on the power

- Once your spa has been filled with water, turn it on and test all the circuit breakers.

Each breaker should be tested prior to each use. Here's how:

1. Push the "TEST" button on each GFCI breaker, and observe it click off.
2. Wait 30 seconds, then push the breaker switch to the OFF (down) position (to ensure that it has completely disengaged), then push the breaker switch to the ON (up) position. If you don't wait 30 seconds, the spa's power indicator may continue to blink – try again.

If any of the GFCI breakers fails to operate in this manner, your spa may have an electrical malfunction, and you may be risking electrical shock. Turn off all circuits and do not use the spa until the problem has been corrected by an authorized service agent.

IMPORTANT: Service Technician must reconfigure spa using the soft jumpers to allow spa heater to run concurrent with jet pump.

⚠ WARNING: Do not allow pliers to contact any electronic components inside the control box.

Converting from 115 volts to 230 volts changes the voltage supplied to the heater from 115-volts to 230 volts. The jet pump will continue to operate at 115 volts.

Have your licensed electrician wire subpanel from a 50A Main Service, then from subpanel into the spa's control box using the following illustration or use the wire diagram on the inside of the control box lid.

IMPORTANT: The subpanel must be placed in sight of the spa, at a minimum distance of 5 feet away.

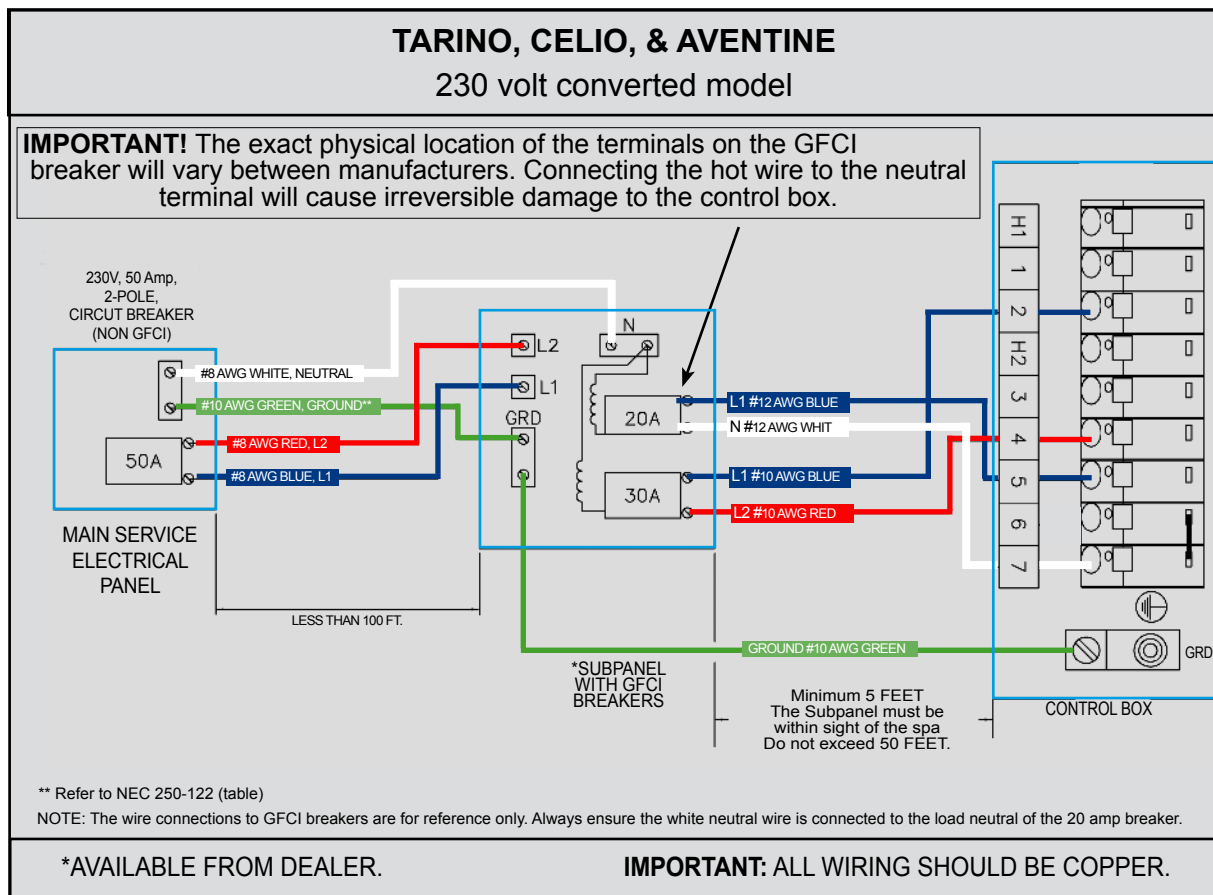

GETTING STARTED

SPA FEATURES PALATINO, MARINO VANTO, TARINO & CELIO MODELS



1) **Standard LCD Control Panel.** The control panel is accessible from inside or outside the spa and is designed for ease of use.



2) The **Air Control** lever lets you dial in the ideal amount of air for the Euro jets.



3) The **Water Feature** lever adjusts the amount of water that flows from the available water feature.



4) The AdaptaFlo[®] jets. These jets allow you to redirect the jet stream by changing the position of the nozzle.



5) The AdaptaSsage[®] jets. These jets provide a rotating massage pattern.



6) The **Euro Directional** jets, with eyeball nozzles, deliver a direct, more focused massage.



7) The **Multi-color LED light** system, you see multiple points of multi-color lighting.



8) The **water feature** adds beauty to your spa experience.

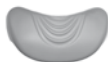

9) **Pillow** - All spas come with one or more pillows.



10) **FRESHWATER** Salt System housing cap.



11) **Spa Filter** provides the water filtration of the spa.

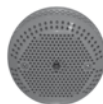

12) The **spa drain/suction**.

WARNING: DO NOT SIT IN THE FILTER COMPARTMENT AREA "THIS IS NOT A SEAT"!!!

Sitting in this area can cause:

- Restriction of filter pump suction/vacuum.
- Damage to components.

Both can result in bodily harm.

Should damage occur to components in this area, replace immediately!

GETTING STARTED

SPA FEATURES AVENTINE MODEL



1) **Standard LCD Control Panel.** The control panel is accessible from inside or outside the spa and is designed for ease of use.



2) The **Air Control** lever lets you dial in the ideal amount of air for the Euro jets.



3) The **ADAPTAFLO** jets. These jets allow you to redirect the jet stream by changing the position of the nozzle.



4) The **Euro Directional** jets, with eyeball nozzles, deliver a direct, more focused massage.



5) **LED** dimmable light.



6) **Pillow** - Spa comes with one pillow.



7) **FRESHWATER** Salt System housing cap.

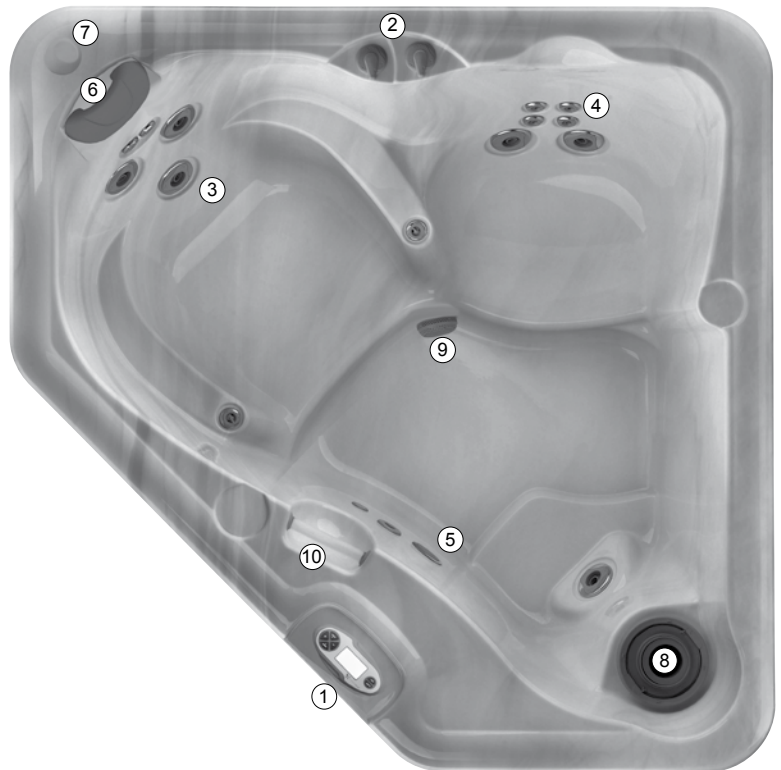

WARNING: DO NOT SIT IN THE FILTER COMPARTMENT AREA

"THIS IS NOT A SEAT"!!!

Sitting in this area can cause:

- Restriction of filter pump suction/vacuum.
- Damage to components.

Both can result in bodily harm.

Should damage occur to components in this area, replace immediately!

ADDITIONAL SPA FEATURES

8) **Spa Filter** provides the water filtration of the spa. (not shown in overhead picture above).

9) The **spa drain/suction**.

10) **Grab Rail**

HYDRO JETS

ADAPTAFLO Jets - These jets allow you to redirect the jet stream by changing the position of the nozzle.

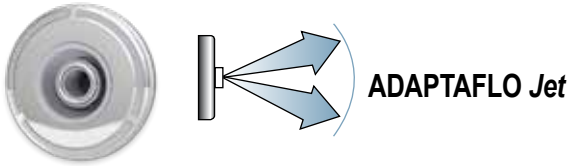

ADAPTASSAGE Jets - These jets provide a rotating massage pattern.

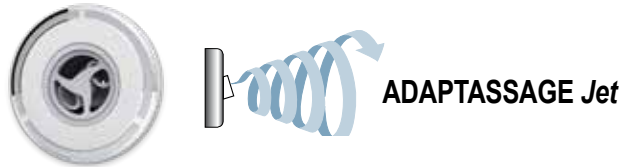

EURO DIRECTIONAL - The Euro Directional jets, with eyeball nozzles, deliver a direct, more focused massage.

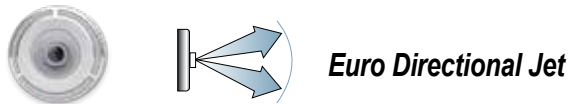

WATERFALL VALVE (AVAILABLE ON SOME MODELS)

The spas are equipped with a cascading water feature. It is activated by pressing the JETS button up to 3 times when the jets are off and turning the waterfall valve clockwise. The flow is regulated by turning the valve to the desired position.

When not in use turn the on/off valve to the OFF position.

DIVERTER VALVE (AVAILABLE ON SOME MODELS)

The diverter valve on your spa allows you to direct the flow of water from the pumps to various combinations of jets. The functions of this diverter valves can best be learned by experimentation.

QUICK START-UP INSTRUCTIONS

BEFORE YOU FILL YOUR SPA

Make sure your spa has been properly installed per all local codes, this includes the location of the spa, the foundation of the spa as well as the electrical installation of the spa. Installation instructions in the form of a Pre-Delivery Instruction booklet can be obtained from either your CALDERA dealer or online.

DO:

- Know which water treatment system you will be using and make sure you have necessary chemicals available. Read all of the instructions that come with the system.
- Have **FRESHWATER** 5-way Test Strips Available.
- Have **FRESHWATER** Salt Test Strips Available if using the Salt system.
- Have pH/Alkalinity Up & Down available.

Know the "Hardness" of your water, contact your dealer to help you with this information. See Water Quality and Maintenance for more information. **IMPORTANT:** Watkins Wellness does not recommend that the spa be filled with "softened" water, as this may damage the spa's equipment.

- Purchase the Clean Screen® pre-filter to remove unwanted contaminants from the tap water. This is recommended, not required.

DON'T:

- Power up the spa until it has been filled with water! Power to the spa automatically activates critical components within the spa, such as controls, heater, circulation pump, and other systems. If power is supplied to these components prior to the spa being filled, the components will be damaged, and this may result in a non-warranty component failure.
- Fill the spa with hot water or cold water with cold water temperature below 50° F (10° C)! Tripping of the high-limit thermostat may result causing your spa to stop functioning.
- Use your spa after filling until all of the steps listed below START-UP are completed!
- Add chlorine if treating your spa with polyhexamethylene biguanide (Biguanide, PHMB, eg. BaquaSpa®) sanitizer.

START-UP

Your **VACANZA** series spa has been thoroughly tested during the manufacturing process to ensure reliability and long-term customer satisfaction. A small amount of water may have remained in the plumbing after testing and, as a result, may have spotted the spa shell or the spa siding prior to delivery. Before filling the spa, wipe the spa shell clean with a soft rag. The following instructions must be read and followed exactly to ensure a successful start-up or refill.

CAUTIONS

- **Do NOT fill the spa with hot water**, as tripping of the high-limit thermostat may result.
- **DO NOT CONNECT POWER TO AN EMPTY SPA.** Power to the spa automatically activates critical components within the spa, such as controls, heater, and other systems. If power is supplied to these components prior to the spa being filled, the components will be damaged, and this may result in a non-warranty component failure.
- **DO NOT** use your spa after filling until all of the steps listed below are completed.
- **DO NOT** add chlorine if treating your spa with polyhexamethylene biguanide (Biguanide, PHMB, eg. BaquaSpa[®]) sanitizer.
- Before filling your spa for the first time, remove the equipment compartment door and check to ensure that the unions on either side of the pump(s) and heater are hand-tight.

Door Removal - see page 31:

- a. Remove the 2 screws on the bottom of each corner.
 - b. Find notches in bottom of panel, place fingers on one side and center notch. Slightly pull on bottom side panel to release 1st clip. Move over to other side and center notch and pull on bottom to release 2nd clip, then lower and remove panel.
1. **CLOSE DRAIN, remove the filter compartment cover, skimmer basket, weir, and filter.** Fill your spa through the filter compartment using the CleanScreen™ pre-filter that attaches to your garden hose. The water level of your spa should be maintained at a level one inch above the highest jet in the spa. Reinstall the filter and then the skimmer basket, and weir once the spa is filled.
IMPORTANT: *Watkins Wellness does not recommend that the spa be filled with "softened" water, as this may damage the spa's equipment.*
 2. **AFTER THE SPA HAS BEEN FILLED** with water and the equipment compartment door is secured, power must be applied to the spa.
 - **115 volt models:** Connect the GFCI to the waterproof receptacle and push the RESET button on the GFCI.
 - **230 volt models:** Open the door of the electrical subpanel, reset the GFCI breaker, verify the system is primed. Close and secure the subpanel door.
 3. **TO CHECK THE OPERATION OF THE JET SYSTEM** and to purge any remaining air from the heating system:
 - Push the JETS button 3 times (twice for **TARINO, CELIO & AVENTINE** models) to run pump(s) on high speed, run for one minute.

Weak or surging jets are an indication of a low water level condition or clogged filter cartridges.

IMPORTANT: Be sure the air Lever (see illustration in Spa Features section) is open by turning clockwise until it stops. Combination jet faces can be turned to completely shut off jet flow, these jets should be open as well.

4. **SET THE TEMPERATURE CONTROL** to the desired temperature between 100°F (38°C) and 104°F (40°C), then place the spa cover on the spa and allow the water temperature to stabilize (approximately 24 hours). Make sure you secure the cover in place using the cover locks. Periodically check the spa water temperature. When the water temperature climbs above 90°F (32°C), proceed to the next step. The spa temperature is pre-programmed to reach 100F (39°C), and will normally do so within 18 to 24 hours. You may change the water temperature by pressing the OPTION hard button then press the soft button next to **Temperature**, (press soft button next to ▲ on the control panel to raise the temperature, or lower temperature by pressing soft button next to ▼). After a few hours, the water temperature will remain within 3°F (1.5°C) of your selected temperature.
5. **USING A TEST STRIP AND APPLICABLE CHEMICALS** adjust Total Alkalinity (TA) to 80 ppm, Calcium Hardness (CH) between **75 - 150 ppm** (if using **Salt System** between **25 - 75 ppm**), then spa water pH to between 7.4 and 7.8. These procedures are listed in the "Water Quality and Maintenance" section.
OPERATION NOTE: *Adjusting the Total Alkalinity as the first step is important, as out-of balance TA will affect your ability to adjust the pH correctly and will prevent the sanitizer from operating effectively.*
*When using the **FRESHWATER** Salt system the Calcium Hardness must be between **25 - 75 ppm**, if hardness is above 75 ppm use **VANISHING ACT** (see pg. 11).*
IMPORTANT: *Activate the Clean cycle (Press the soft button next to CLEAN on the home screen) before adding spa water chemicals directly into the filter compartment. Make sure all diverter valves are set to the middle position.*
6. **SUPERCHLORINATE THE SPA WATER** by adding 1½ teaspoons of **FRESHWATER** chlorine (sodium dichlor) per 250 gallons (950 liters) of spa water, then activate the Clean cycle.
7. **TEST THE SPA WATER FOR CHLORINE RESIDUAL.** If the residual is between 1 - 5 ppm on the test strips, go on to the next step. If the residual is less than 1 ppm, activate the Clean cycle, and then retest, add more chlorine as necessary.
WARNING: *High sanitizer levels can cause discomfort to the user's eyes, lungs and skin. Always allow the sanitizer level to fall to the recommended range before using the spa.*
8. **RECHECK** the Total Alkalinity (TA) 40 - 120 ppm, Calcium Hardness (CH) 75 - 150 ppm, then spa water pH at between 7.2 - 7.8.
OPERATION NOTE: *Make sure you adjust your Total Alkalinity and pH correctly, this will affect the sanitizers effectiveness.*
The spa is ready for use when the spa water has circulated and the chlorine level remains between 1 - 5 ppm.
OPERATION NOTE: For proper water circulation during the ten-minute Clean cycle the following steps should be performed.
 - Place the diverter valve in the middle (split flow) position
 - Place air control levers in OFF position by rotating clockwise

EQUIPMENT COMPARTMENT

The illustration below is to be used as a reference only (your spa may look different). The equipment compartment is located behind the front panel of the spa below the Main Control Panel.

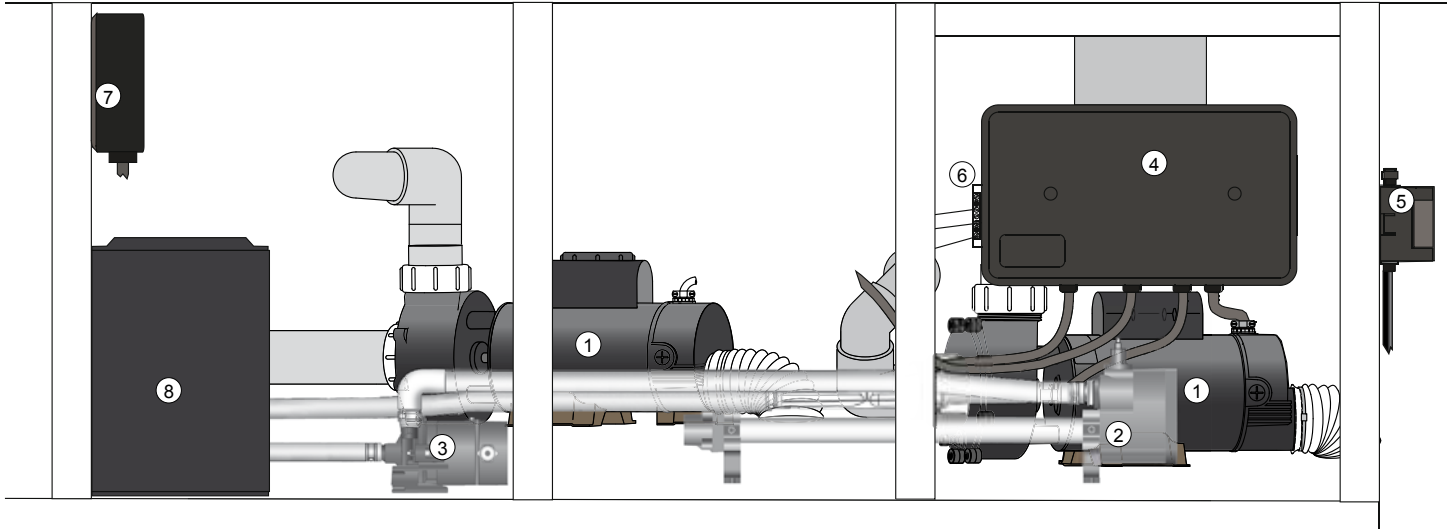

- | | |
|---------------------------------------|-------------------------------|
| 1. Jet pump* | 5. Ozone Generator (optional) |
| 2. EnergyPro® heater | 6. Bonding terminal |
| 3. ENERGY PRO Circulation Pump | 7. Bluetooth Music (optional) |
| 4. Advent® Control Box | 8. Subwoofer (optional) |

OPERATING INSTRUCTIONS

CONTROL OPERATION

Your control panel consists of an LCD display and convenient touch pads that allow you to set the water temperature and adjust the skim/ filter cycle settings, lock spa temp, lock all spa functions, as well as control the hydrotherapy jets, and lights.

LCD DISPLAY INVERSION

You may invert the control panel display for easier viewing from inside the spa. To invert the display the following is required: Press the MODE(▼) and (-) buttons simultaneously. By pressing the MODE(▼) and (-) buttons simultaneously a second time the screen will go back to it's original display.

MODE BUTTON

From the Home screen use the **MODE** (▲ or ▼) button to scroll to the System, Clean, Audio (if your spa is equipped), **FRESHWATER** Salt (if equipped) and Tools screen. Press the (+) button to enter into the sub screens.

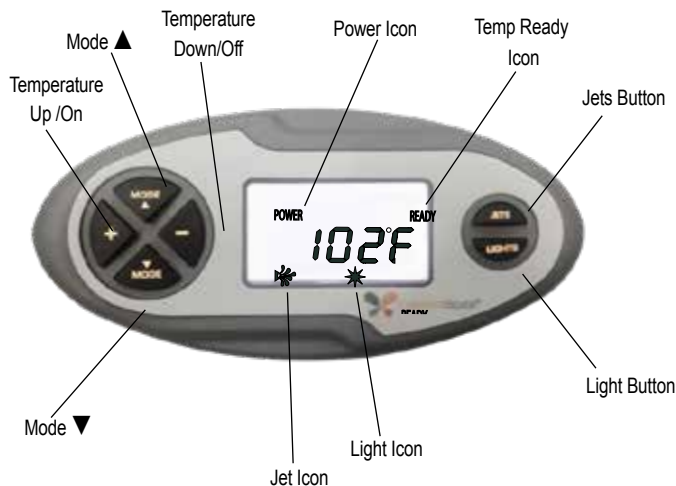

TEMPERATURE CONTROL



The set temperature range is from 80°F (26°C) to 104°F (40°C). Temperatures of any setting may rise slightly depending on the current use and condition of your spa, and on outside temperature. Whenever power is

disconnected and then reconnected to the spa, the water temperature setting will automatically return to the last temperature entered into the program.

To increase the set temperature, press the (+) button, once for each degree of increase temperature desired. If you hold the (+) button down, the set temperature will increase by one degree every half second.

To decrease the set temperature, press the (-) button, once for each degree of decreased temperature desired. If you hold the (-) button down, the set temperature will decrease by one degree every half second.

JET PUMP CONTROL

Pressing the "JETS" button changes the jet pump functions, depending on the number of presses:



PALATINO, MARINO & VANTO MODELS ONLY:

- 1st press: System 1 jet pump runs on low speed
- 2nd press: System 1 jet pump runs on high speed
- 3rd press: System 1 & System 2 jet pumps run on high speed
- 4th press: System 2 jet pump runs on high speed
- 5th press: Both Systems jet pumps are off

TARINO, CELIO & AVENTINE MODELS ONLY:

- 1st press: System 1 jet pump runs on low speed
- 2nd press: System 1 jet pump runs on high speed
- 3rd press: Jet pump off

The pump on high speed automatically turns off after operating for one hour. The pump on low speed automatically turns off after operating for one hour.

When the jets are active, the JETS icon on the control panel will illuminate.

LIGHT - ON/OFF & INTENSITY CONTROLS

The light control uses four positions: High, Medium, Low, and Off. To turn on the spa light, press the LIGHT button. This will place all lights in the spa in the High, or maximum intensity position. When the lights turn on, the light symbol will also illuminate on the control panel display. Press the LIGHT button again to lower the intensity of the lights to the Medium position. Press the LIGHT button again to lower the intensity even more, placing the lights intensity in the Low position. Press the LIGHT button one more time to shut the lights off. When the light is deactivated, the light symbol will also turn off.

If the lights are left on, they will automatically be turned off by the control system after 6 hours of continuous operation. The light symbol on the panel will also turn off when the lights are deactivated.

If the lights will not turn on, make sure SPA LOCK is deactivated. SPA LOCK disables the controls on the control panel (see following pages for more information on SPA LOCK).

SYSTEM MODE

Your spa is equipped with a System Mode. This function will allow you to conveniently turn the jet(s) on high speed and the lights on maximum intensity at the same time.

To activate the System Mode, perform the following functions:

Press the MODE (▲ or ▼) button until SYSON is displayed on the screen. Press the (+) button to activate the SYSON mode feature. The jets and light icons will remain illuminated on the display until the system mode is deactivated.



NOTE: Once activated, the jet and light functions can still be changed by pressing the JETS or LIGHT button.

To deactivate the System Mode, press the MODE (▲ or ▼) button until the SYSON symbol is displayed on the screen. Press the (-) button to deactivate.

CLEANING MODE

All spas are equipped with a "Cleaning" mode. When the mode is activated, the jet pump in the first jet system will turn on and run for ten minutes (used for water maintenance). To activate the "Cleaning" mode, press the MODE (▲ or ▼) button several times until the CLEAN menu is displayed. Press the (+) button to activate the CLEAN mode feature.



NOTE: The jet icon will flash on and off while the "Cleaning" mode is active.

To stop the Cleaning Cycle before the ten minutes is complete, Press the MODE (▲ or ▼) button several times until the CLEAN menu is displayed on the screen then press the (-) button to deactivate.

NOTE: Pressing the JETS button will also deactivate the clean cycle and the jet icon will remain on and solid

TOOLS MENU

The TOOLS menu is one of the main menus on the control panel. Within the TOOLS menu are several submenus, which consists of; Temp Lock, Spa Lock, Light, LCD, Vanishing Act and Exit.

To enter onto the TOOLS menu, scroll through the main menu using the MODE (▲ or ▼) button until TOOLS is displayed. Press the (+) button to enter into the TOOLS submenu, use the MODE (▲ or ▼) button to scroll through the submenus. Once the desired submenu is displayed, press the (+) button to activate that submenu. To leave the TOOLS submenu, scroll through the submenu using the MODE (▲ or ▼) button until EXIT is displayed, then press the (+) button to exit the submenu.

LOCKING FEATURES

The two locking features, SPA LOCK and TEMPERATURE LOCK, are enabled from the control panel by pressing the MODE (▲ or ▼) button until TOOLS is displayed. Then press the (+) button to enter the TOOLS submenus. Use the MODE (▲ or ▼) button to scroll through the submenus to get to the locking features. Once enabled, a lock will remain active until the specific button combination is applied to disable the lock. Even if power is disconnected from the spa and soon thereafter reapplied (such as in a power outage) the lock will remain in place.

TEMPERATURE LOCK

The TEMPERATURE LOCK feature deactivates the temperature control function of the control panel. TEMPERATURE LOCK is most often used by people who do not want others to tamper with or change the set temperature of the spa water. TEMPERATURE LOCK is a submenu of the TOOLS menu

To activate the TEMPERATURE LOCK, press the MODE (▲ or ▼) button in the TOOLS submenu until the TLOK- symbol is displayed on the screen. Press the (+) button to activate the TEMPERATURE LOCK feature (TLOK+).

When the TEMPERATURE LOCK is activated, the JETS, LIGHTS and any other features your spa may have will operate normally, and the temperature setting can be viewed but can NOT be changed. If a temperature button is pressed, TLOK will display for several seconds, then turns off.

To deactivate the TEMPERATURE LOCK, press the MODE (▲ or ▼) button in the TOOLS submenu until the TLOK+ symbol is displayed on the screen. Press the (-) button to deactivate the TEMPERATURE LOCK feature.

SPA LOCK

The SPA LOCK feature deactivates all of the functions of the control panel. It is generally used to prevent unwanted use of the spa. The SPA LOCK menu is a submenu of the TOOLS menu.

To activate the SPA LOCK, press the MODE (▲ or ▼) button in the TOOLS submenu until SLOK- is displayed on the screen. Press the (+) button to activate the SPA LOCK feature.

When the SPA LOCK is activated, the buttons for the jets, temperature control, light, and any other features your spa may have are deactivated.



If Jets, Light button, or (+) or (-) button is pressed, the SLOK will display for several seconds, then turns off.

To deactivate the SPA LOCK, press the MODE (▲ or ▼) button in the TOOLS submenu until the SLOK+ symbol is displayed on the screen. Press the (-) button to deactivate the SPA LOCK feature.

LOCK OVERRIDE

The Lock Override feature is for spa users who normally keep the set temperature locked. Should the user wish to lock all spa controls temporarily, the spa lock can be applied over an already-applied temperature lock. Then, when the spa lock is removed, the temperature lock will remain on to prevent unwanted tampering with the set temperature.

LIGHT - MULTI-COLOR MENU CONTROLS (AVAILABLE ON SOME MODELS)

Your spa lights can display a variety of different colors as well as run through a continuous sequence of colors (loop) at different speeds. To activate this function the following is required:

Press the MODE (▲ or ▼) button to scroll to the TOOLS screen. Once displayed, press the (+) button to enter the TOOLS submenu. Press the MODE (▲ or ▼) button to scroll to LIGHT screen, press the (+) button to enter DIM, screen. Press the (+) button or (-) button in the DIM screen to adjust the brightness of the lights. Press the MODE (▲) button to scroll to Color screen. Press the (+) button or (-) button in the COLOR screen as many times as desired to toggle through the different light colors. Press the MODE (▲) button to scroll to Loop screen. Press the (+) button or (-) button in the LOOP screen to select a continuous sequence of colors, the higher the loop number the faster the color sequence will run. Press the MODE (▲) button to scroll to EXIT screen. Press the (+) button in the EXIT screen to exit the LIGHT menu.

If the lights are turned off while in the COLOR mode, the same COLOR will exist when the lights are reactivated. If in loop mode the color will go to blue when reactivated.

VANISHING ACT

The **VANISHING ACT** Cycle will activate the low speed jet pump for 6 hours, ONLY to be used with **VANISHING ACT** (see page 23)

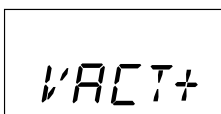

Enter into the Vanishing Act screen from the control panel by pressing the MODE (▲ or ▼) button until TOOLS is displayed. Then press the (+) button to enter the TOOLS submenu.

Use the MODE (▲ or ▼) button to scroll through the submenus to get to the Vanishing Act Screen. Press the (+) button to activate the Vanish Act

BRIGHTNESS - LCD

If you would like to change the brightness of the Control Panel screen:

- Press the MODE (▲ or ▼) button until the TOOLS menu is displayed.
- Press the (+) button to enter the TOOLS submenus.
- Press the MODE (▲ or ▼) button until LCD is displayed.
- Press the (+) button to enter into the LCD menu.
- Using the (+) or the (-) button, adjust the desired screen brightness.

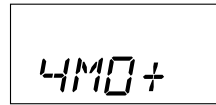
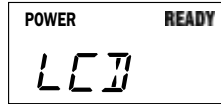

4 Month Cartridge change: This will be displayed after 4 months when entering the Salt System menu as a reminder to replace the Salt System cartridge as described in the Salt System manual under "Ongoing Maintenance" Step 3. **ONLY** press the + button if you want to acknowledge notice and suppress notice for another 7 days (if you want to change the cartridge see below).



Scroll through the Salt system menus using the **MODE** (▲ or ▼) button until you see the CHNG+ screen. Press + button to activate the change cartridge process. Follow prompts to remove and insert the cartridge and press + button when prompted with OK+. See step 3 in the Salt manual under "Ongoing Maintenance" for more information about Changing the Cartridge.

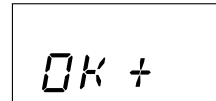

FRESHWATER SALT SYSTEM (OPTIONAL)

If your spa has the **FRESHWATER** Salt System installed you can navigate to the screen as follows:

- From the Home screen use the **MODE** (▲ or ▼) button to scroll to the Salt System menu
- Press the (+) button on the control panel to enter into the Salt System menu.
(see **FRESHWATER** Salt System owner's manual for more information).

The Following screens will be visible once the Salt System is installed:

It is important to read the **FRESHWATER** Salt System Owner's manual, it will explain the functions of the following screens in more detail.



Scroll through the modes until this screen is visible. Press + to enter the Salt system menus.

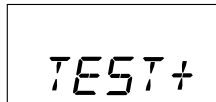

Scroll through the Salt system menus using the **MODE** (▲ or ▼) button until you see the TEST+ screen. Press + button to activate the Test. See step 2 in the Salt manual under "Ongoing Maintenance" for more information about the Test mode.

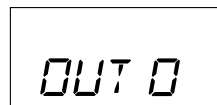

Scroll through the Salt system menus using the **MODE** (▲ or ▼) button until you see the OUT screen. Press + button to enter the System Output screen. Press the + or minus button to change between 0-10. See step 7 under "Getting Started" in the Salt system Owner's Manual on where to set the Salt System Output Level.

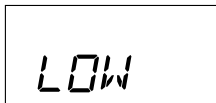

Error Messaging: One of these two messages will be displayed when entering the Salt System menu should a High or Low Status occur. Follow the information in the Salt System Owner's Manual under Troubleshooting for System Status High or System Status Low to resolve the issue.

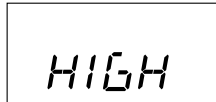
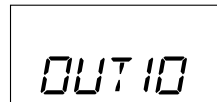

Scroll through the Salt system menus using the **MODE** (▲ or ▼) button until you see the BOST+ screen. Press the + button to activate the Boost screen or the - button to deactivate the 24 hour boost cycle. See "Boost" under "System Features" in Salt manual.

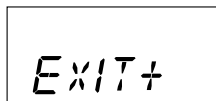

Scroll through the Salt system menus using the **MODE** (▲ or ▼) button until you see the EXIT+ screen. Press + button to leave the Salt System menu.

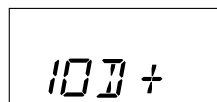

10 Day timer: This will be displayed after 10 days when entering the Salt System menu as a reminder to test spa water every 10 days as described in the Salt System manual under "Ongoing Maintenance" Step 2. Press the + button to confirm and cancel notice.

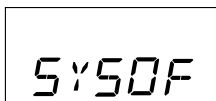

System Off message. When the OUTPUT for the Salt system is set to 0 this screen will be displayed when entering the Salt menu.



The POWER/READY will alternately flash when there is a water care issue.

AUDIO MENU (OPTIONAL)

The following applies to spas that have an optional wireless audio system installed:

When the wireless audio system has been installed on the spa, the control panel can be used to control the audio system. The following information demonstrates how to navigate the music menu by using the spa's control panel.

AUDIO MENU

Once the music system is installed, an AUDIO menu will be accessible on the control panel screen.

To access the menu, press the MODE (▲ or ▼) button until AUDIO is displayed.

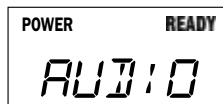

BASIC CONTROL PANEL OPERATION

1. To enter into a sub-menu press the (+) button.
2. To move to the next menu press the MODE (▲) button
3. To exit from any sub-menu, press MODE (▲ or ▼) button as many times as necessary until EXIT is displayed then press the (+) button to exit that sub-menu.

TO TURN AUDIO SYSTEM ON/OFF

From the AUDIO screen:

1. Press the (+) button to display POWR -.
2. Press the (+) button to display POWR + and turn the audio system ON. Press the (-) button to display PWR - and turn the audio system OFF.

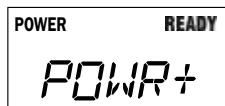

IMPORTANT: The power can take a few seconds to turn on or off.

TO PAIR BLUETOOTH

On your device go to Bluetooth settings and find either *My Spa Music* or *My Spa BTXR*.

For *My Spa Music*:

1. Press *My Spa Music* using the standard pairing method on your mobile device.
2. Enter pairing number 0000 if asked to complete the pairing.

For *My Spa BTXR*:

1. Press the MODE (▲ or ▼) button until the SETUP screen is displayed.
2. Press the (+) button to display one of three audio sources, BLUE, TV, AUX in the setup menu. Bluetooth should be selected.
3. Press the MODE (▲ or ▼) button until the PAIR+ screen is displayed.
4. Press the (+) button followed by pressing "connect" next to *My Spa BTXR* on your device.
5. After pairing, you will be ready to use your Bluetooth device. Only one paired Bluetooth device will work at a time.

TO ADJUST VOLUME

From the AUDIO screen:

1. Press the (+) button to display POWR.
2. Press the MODE (▲) button to display VOL.
3. Press the (+) button to increase volume and the (-) button to decrease volume.

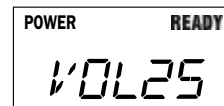

NOTE: Volume range is from 0-40. No number displayed indicates Volume is OFF.

TO PAUSE/PLAY

From the AUDIO screen:

1. Press the (+) button to display POWR.
2. Press the MODE (▲ or ▼) button until PLAY is displayed.
3. Press the (+) button to start the song or the (-) button to pause the song.

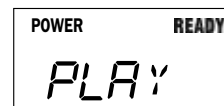

TO CHANGE TRACK

From the AUDIO screen:

1. Press the (+) button to display POWR.
2. Press the MODE (▲ or ▼) button until TRACK is displayed.
3. Press either (+) button or (-) button to change the track (song).



TO GO TO SETUP MENU

From the AUDIO screen:

1. Press the (+) button to display POWR.
2. Press the MODE (▲ or ▼) button until SETUP is displayed.

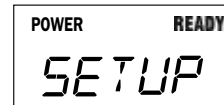

TO CHANGE AUDIO SOURCE

From the SETUP screen:

1. Press the (+) button to display one of three audio sources, BLUE, TV, AUX.
2. Press the (+) button to raise to the next source or press the (-) button to lower to the next source. Go to the source you will be using.

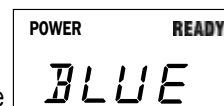

NOTE: Blue = Bluetooth®. To use the Bluetooth screen, your audio Bluetooth device must be paired with the spa.

TO ADJUST TREBLE

From the SETUP screen:

1. Press the (+) button to display one of three audio sources, BLUE, TV, AUX.
2. Press the MODE (▲ or ▼) button until TRE -5 to +5 is displayed.
3. Press (+) button to raise the Treble or press (-) button to lower the treble.

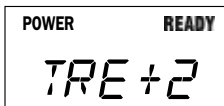

TO ADJUST BASS

From the SETUP screen:

1. Press the (+) button to display one of three audio sources, BLUE, TV, AUX.
2. Press the MODE (▲ or ▼) button until BAS -5 to +5 is displayed.
3. Press (+) button to raise the Bass or press (-) button to lower the Bass.

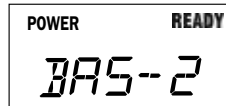

TO ADJUST BALANCE

From the SETUP screen:

1. Press the (+) button to display one of three audio sources, BLUE, TV, AUX.
2. Press the MODE (▲ or ▼) button until BAL -5 to +5 is displayed.
3. Press (+) button to raise the Balance number or press (-) button to lower the Balance number.



TO ADJUST SUBWOOFER

From the SETUP screen:

1. Press the (+) button to display one of three audio sources, BLUE, TV, AUX.
2. Press the MODE (▲ or ▼) button until SUB 0 to 11 is displayed.
3. Press (+) button to raise the subwoofer number or press (-) button to lower the subwoofer number.

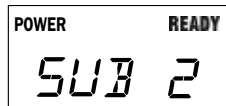

TO PAIR BLUETOOTH DEVICE

For *My Spa Music*:

1. Press *My Spa Music* using the standard pairing method on your mobile device.
2. Enter pairing number 0000 if asked to complete the pairing.

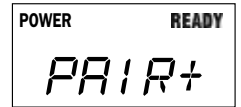

For *My Spa BTXR*:

From the SETUP screen:

1. Press the (+) button to display one of three audio sources, BLUE, TV, AUX.
2. Press the MODE (▲ or ▼) button until PAIR is displayed.
3. Press (+) button followed by pressing "connect" next to *My Spa BTXR*.
4. Press the MODE (▲) button to display the signal strength (0-5) between your device and the spa.



TO DISCONNECT BLUETOOTH (RESET)

From the SETUP screen:

1. Press the (+) button to display one of three audio sources, BLUE, TV, AUX.
2. Press the MODE (▲ or ▼) button until RSET+ is displayed.
3. Press (+) button to disconnect any device using the spa music system so that another paired device may be used. This is also necessary when trying to pair multiple devices because pairing is NOT possible when another device is connected to the music system.



JET MENUS PALATINO



System 1

- a. 2 **ADAPTAFLO** Jets
- b. **ACQUARELLA** Waterfall
- c. 10 Euro Jets in Lounge
- d. 1 **ADAPTAFLO** Jet, 2 **ADAPTASSAGE** Jets and 4 Euro Jets in Lounge
- e. 2 Euro Jets and 1 **ADAPTAFLO** Jet



System 2

- a. 10 Euro Jets
- b. 4 Euro Jets and 2 **ADAPTASSAGE** Jets
- c. 2 **ADAPTAFLO** Jets and 1 Euro Jet
- d. 4 Euro Jets in footwell

MARINO



System 1

- a. 8 Euro Jets
- b. 2 **ADAPTAFLO** Jets
- c. **ACQUARELLA** Waterfall
- d. 3 Euro Jets
- e. 2 Euro Jets in footwell
- f. 2 Euro Jets and 1 **ADAPTAFLO** Jet



System 2

- a. 4 Euro Jets and 2 **ADAPTASSAGE** Jets
- b. 4 Euro Jets in Lounge (calf area)
- c. 2 Euro Jets and 2 **ADAPTAFLO** Jets and 1 **ADAPTASSAGE** in Lounge
- d. 2 Euro Jets in footwell

JET MENU VANTO



System 1

- a. 8 Euro Jets
- b. **ACQUARELLA** Waterfall
- c. 3 Euro Jets
- d. 6 Euro Jets and 1 **ADAPTAFLO** Jet
- e. 4 Euro Jets in footwell



System 2

- a. 2 **ADAPTAFLO** Jets
- b. 4 Euro Jets and 2 **ADAPTASSAGE** Jets
- c. 2 Euro Jets, 2 **ADAPTAFLO** Jet and 1 **ADAPTASSAGE**

TARINO

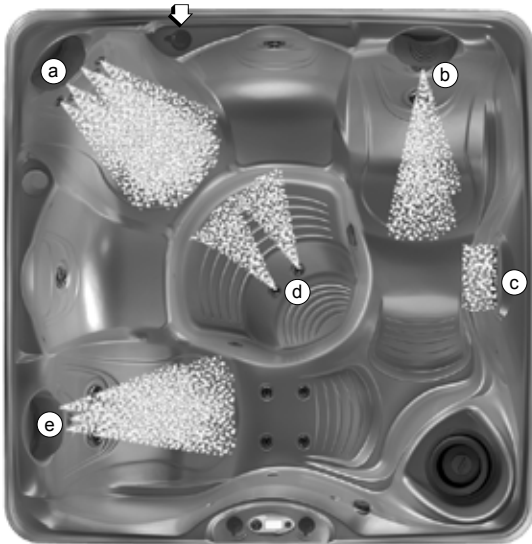

System 1 Menu A (Diverter in position)

- a. 8 Euro Jets
- b. 2 **ADAPTAFLO** Jets (Lounge)
- c. **ACQUARELLA** Waterfall
- d. 2 Euro Jets in footwell
- e. 3 Euro Jets and 2 **ADAPTAFLO** Jet (Lounge)



System 1 Menu B (Diverter in position)

- a. 8 Euro Jets
- b. 1 **ADAPTASSAGE** Jet
- c. **ACQUARELLA** Waterfall
- d. 4 Euro Jets in Lounge (calf area)
- e. 3 Euro Jets and 2 **ADAPTAFLO** Jets (Lounge)
- f. 1 **ADAPTASSAGE** Jet

JET MENU

CELIO

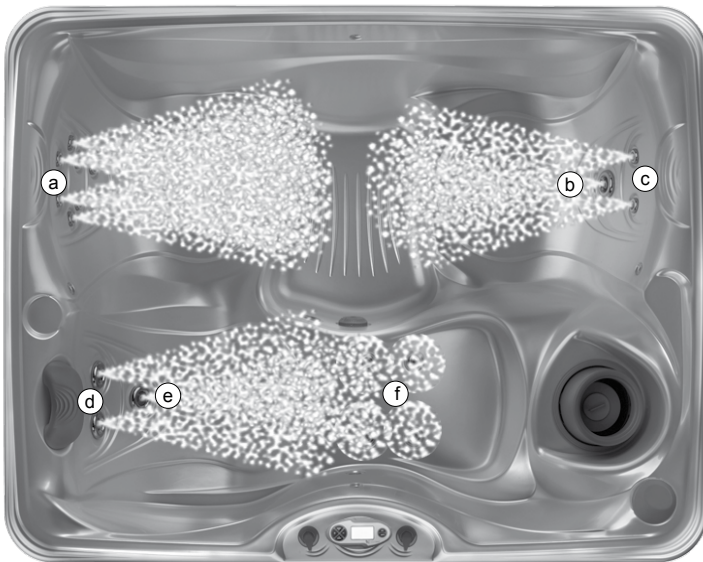

System 1

- a. 8 Euro Directional Jets
- b. 1 ADAPTAFLO Jet
- c. 2 Euro Directional Jets
- d. 2 ADAPTAFLO Jets
- e. 1 ADAPTASSAGE Jet
- f. 4 Euro Directional Jets in Lounge (calf jets)

AVENTINE



System 1

- a. 2 Euro Jets
- b. 3 ADAPTAFLO Jets
- c. 2 Euro Jets in arm rests
- d. 4 Euro Jets
- e. 2 ADAPTAFLO Jets
- f. 1 ADAPTAFLO Jet

WATER QUALITY AND MAINTENANCE

BASIC INFORMATION

It's important to have clean water. Water maintenance is one of the least understood, yet most important, areas of spa ownership. Your dealer can guide you through the process of achieving and maintaining balanced water in your spa, given your local conditions.

IMPORTANT: Water Terminology can be found at the end of this section.

- **Always read & refer to the owner's manual** for complete information.
- **Test your water** with a test strip once a week, or each time the spa is used.
- **Add chemicals** in frequent small amounts to prevent overdosing the spa.
- **When using the Salt System System** read & refer to separate owner's manual.
- **Use the spa only** when the chlorine level is between 1 - 5 ppm or manually add chlorine as needed.
- **It is the spa owner's responsibility** to prevent over or under chlorination.

IMPORTANT: Remember to change your water every three to four months. Check with your **CALDERA** dealer to determine if water in your region has unique qualities - such as high metal or mineral content - that should be addressed.

Your program will depend on your water's mineral content, how often you use your spa, and how many people use it.

WATER QUALITY CHART

PARAMETER	TARGET	MIN - "OK" RANGE - MAX
pH	7.4	7.2 - 7.8
ALKALINITY	80 ppm	40 ppm - 120 ppm
HARDNESS	100 ppm	75 ppm - 150 ppm
HARDNESS (SALT SYSTEM)	50 ppm	25 ppm - 75 ppm
CHLORINE	3 ppm	1 ppm - 5 ppm

Maintaining the water quality and the cleanliness of the filter in your spa is your responsibility. Keeping the spa water balanced prolongs the life of the spa components and will make the water more comfortable. Your dealer can guide you through the process of achieving and maintaining perfect water in your spa, given your local conditions. Your program will depend on your water's mineral content, how often you use your spa, and how many people use it. Watkins Wellness has developed several water care systems and products to simplify water care which are available from authorized **CALDERA** dealers.

FRESHWATER Salt System	Vanishing Act™ Calcium Remover
FRESHWATER Salt Test Strips	CLEAN SCREEN Prefilter
FRESHWATER 5-way Test Strips	

CHEMICAL SAFETY

When using chemicals, read the labels carefully and follow directions precisely. Though chemicals protect you and your spa when used correctly, they can be hazardous in concentrated form. Always observe the following guidelines:

- Allow only a responsible person to handle spa chemicals. Keep them out of the reach of children.
- Accurately measure the exact quantities specified, never more. Do not overdose your spa.
- Handle all containers with care. Store in a cool, dry, well ventilated place.
- Always keep chemical containers closed when not in use. Replace caps on their proper containers.
- Don't inhale fumes, or allow chemicals to come in contact with your eyes, nose, or mouth. Wash your hands immediately after use.
- Follow the emergency advice on the product label in case of accidental contact, or if the chemical is swallowed. Call a doctor or the local Poison Control Center. If a doctor is needed, take the product container along with you so that the substance can be identified.
- Don't let chemicals get on surrounding surfaces or landscaping. Don't use a vacuum cleaner to clean up chemical spills.
- Never smoke around chemicals. Some fumes can be highly flammable.
- Don't store any chemicals in the spa equipment compartment.

HOW TO ADD CHEMICALS TO THE WATER

IMPORTANT: All spa water chemicals must always be added directly into or in front of the filter compartment while a jet pump is running, and it must run for a minimum of ten minutes.

To Administer Spa Water Chemicals:

1. Fold back the cover. Carefully remove and set aside the filter compartment cover.
2. On your Control Panel:
Push the MODE (▲ or ▼) button several times until the CLEAN menu is displayed. Press the (+) button to activate the CLEAN mode feature.
3. Carefully measure the recommended amount of chemical and slowly pour it into the filter compartment. Use care not to splash chemicals on your hands, in your eyes, on the spa shell surface, or on the spa cabinet.
4. Replace the filter compartment cover. After ten minutes, the jet pump will automatically shut off to complete the procedure. Close and secure the cover.

 **DANGER:** Risk of Drowning: Never leave an open spa unattended!

IMPORTANT: After administering a super chlorination treatment or non-chlorine shock to your spa, leave the cover open for a minimum of 20 minutes to allow the oxidizer gas to vent. A high concentration of trapped oxidizer gas which may exist as a result of the shock treatment (not daily sanitation) may eventually cause discoloration or vinyl degradation to the bottom of the cover. This type of damage is considered chemical abuse and is not covered under the terms of the limited warranty.

FUNDAMENTALS OF WATER MAINTENANCE

- **Testing:** Test the water weekly or each time the spa is used with convenient 5-way test strips or more accurate liquid/tablet reagent test kit per instructions. Critical parameters: sanitizer level, pH, Calcium Hardness (CH), and Total Alkalinity (TA). Store test equipment in a dark, cool, dry place to maintain potency.
- **Water Filtration:** The filtration used in **CALDERA** spas helps keep water clean by circulating sanitizer and removing waste from the spa. Regularly inspect and clean filters for peak performance.
- **Chemical Balance/pH Control:** It is important to adjust the primary water parameters (Total Alkalinity, Calcium hardness, pH) into the recommended ranges so that they are stabilized or balanced. Balance the water chemistry every time you fill the spa with new water and then during the life of that body of water. Keeping the water in balance prevents damage by holding the pH in a safe range and preventing calcium scale formation on spa equipment. A low pH can damage metal components whereas a high pH can cause high levels of calcium to form scale. Your dealer should provide a detailed water chemistry orientation soon after your new spa is filled for the very first time.

ALKALINE SPA WATER (SCALING ZONE)	8.2	ADD pH DECREASER TO LOWER pH
	7.8	
COMFORT ZONE	7.6	IDEAL
	7.4	
	7.2	
ACIDIC SPA WATER (CORROSIVE ZONE)	6.8	ADD pH INCREASER TO RAISE pH
	pH	

- The following three water components must be kept in balance to avoid damage to the spa. Do balance these components in the order they are listed here as each will help you balance the next using a minimum amount of chemicals.
1. **Calcium Hardness (CH)** – CH is the measure of the amount of dissolved calcium in the water. Low levels can make the water corrosive and high levels cause scale formation of spa components. The recommended CH reading is between **75 - 150 ppm**. A hardness between **25 - 75 ppm** is recommended with a **Salt System**. If the CH level is too high, lower it with the **VANISHING ACT** calcium remover per instructions. Once in balance, the CH reading normally remains stable until new water is added. Great care must be taken when filling the spa from a water softener to ensure that the calcium remains in balance and avoid damage to the spa.
 2. **Total Alkalinity (TA)** - TA is a measure of the water's ability to resist changes of pH or buffer capacity. A low TA allows the pH to fluctuate easily. The recommended TA reading is between **40 - 120 ppm**. To raise the TA, use pH/Alkalinity Up (sodium hydrogen carbonate). To lower the TA, use pH/Alkalinity Down (sodium bisulfate). Once the TA is balanced, it normally remains stable until the next drain/refill. We recommend you check the TA reading once per month. Raising/lowering the TA may cause the pH readings to fluctuate widely. Ignore the pH readings on the test strip while you are balancing the TA.
 3. **pH** - The pH is the measure of the acidity and alkalinity. Maintaining the proper pH level will optimize the effectiveness of the sanitizer, preventing damage to the spa and physical discomfort for spa users. A low pH dissipates sanitizer, causes corrosion, and irritates spa users. A high pH level will neutralize sanitizer, promote scaling and cloud water. The recommended pH reading is between **7.2 - 7.8**. To lower the pH level, use pH/Alkalinity Down (sodium

bisulfate). To raise the pH level, use pH/Alkalinity Up (sodium carbonate).

- **Water Conditioners:** Spa fill water varies from location to location and user to user, therefore it is important to consult with your dealer for an appropriate program.
 - a. **VANISHING ACT** – High levels of calcium and some minerals can be removed from the water with the single use **VANISHING ACT**. High calcium levels can cause scale formation on the spa equipment and shell.
 - b. **CLEAN SCREEN** pre-filter –The **CLEAN SCREEN** pre-filter should be used at every fill and top-off to remove contaminants from the fill water, especially iron, copper, and manganese. Many water sources including well water contain high concentrations of minerals that can cause staining of the shell and plastics.
 - c. **Stain and Scale control** – For water high in calcium and minerals, it may be necessary to use an anti-scalant like Stain and Scale control. As water evaporates from your spa and new water is added, the amount of dissolved minerals like calcium, copper, iron, and manganese will increase. (Minimize evaporation by keeping the cover on the spa whenever possible.) High iron or copper content in the water may produce green or brown stains on the spa.
 - d. **Foam Inhibitors** - Soap is introduced into the spa water from users' bodies and swimming apparel and can cause the spa water to foam when the jets are used. Low levels of calcium hardness (soft water) can increase foaming. Although ozone can oxidize soap residual, it may become necessary to add Foam Inhibitors to suppress the foam. Excessive soap in the water may require a water change to resolve.
- **Oxidizers:** Ozone and Monopersulfate (MPS) are oxidizers used to prevent the buildup of contaminants, maximize sanitizer efficiency, minimize combined chlorine, and improve water clarity. They are to be used in conjunction with EPA registered sanitizers. The high output ozone system uses a Corona Discharge technology to produce a high concentration of ozone which is injected into the spa water 24 hours per day. Chlorine-Free Oxidizer, Monopersulfate (MPS) is a granular oxidizing chemical.
- **Sanitizers:** Maintaining the recommended residual level of an EPA registered sanitizer at all times will decrease the occurrence of unsafe bacteria and viruses in your spa water. The recommended Free Available Chlorine (FAC), the amount of available chlorine sanitizer, is **3.0 - 5.0 ppm**. A low FAC can allow bacteria and viruses to grow rapidly in the warm water, and a high FAC can cause discomfort to the user's eyes, lungs, and skin. Each sanitizer carries its own instructions regarding how much to use and when to add it to the spa water. Consult your dealer for their recommendations and instructions on proper sanitizing of the spa.

WATKINS WELLNESS recommends the following sanitizers:

- **FRESHWATER CLEAN SCREEN** Pre-filter
- **FRESHWATER** Concentrated Chlorinating Granules
- **FRESHWATER** Monopersulfate (MPS), Chlorine-Free Oxidizer
- **FRESHWATER** Mineral Spa Sanitizer (not compatible on Aventine)
- **VANISHING ACT** calcium remover

WARNING: DO NOT use tri-chlor chlorine, bromo-chloro-dimethyl-hydantoin (BCDMH), or any type of compressed bromine or chlorine, acid or any type of sanitizer which is not recommended by **WATKINS WELLNESS**.

THE CALDERA SPA WATER MAINTENANCE PROGRAM

FILLING THE SPA WITH WATER

Use the **FRESHWATER CLEAN SCREEN** pre-filter to remove unwanted contaminants such as rust, dirt, detergents, and algae from the fill water. Dissolved metals, copper, iron, and manganese are also removed. Instructions are included with the **CLEAN SCREEN** pre-filter. Always fill the spa through the filter compartment. Do not fill your spa using water from a swimming pool as pool chemicals are very different from those used in a spa and can damage your spa.

ADDING CHEMICALS TO THE WATER

All spa water chemicals, including granulated dichlor, MPS, granulated pH increaser or decreaser, granulated total alkalinity increaser, liquid stain and scale inhibitor, and liquid defoamer must always be added directly into the filter compartment while the jet pump is running in its high speed mode, and it must run for a minimum of ten minutes with the cover off. Use the Clean button/feature to ensure that the chemicals are properly mixed when adding.

BUILDING A SANITIZER ROUTINE

During the first month of ownership, measure the sanitizer residual daily in order to establish a baseline of sanitizer needed vs. spa usage. Sanitizer needed is the amount of Free Available Chlorine needed to accommodate the number of users and their combined usage time. For example, two spa users for twenty minutes every day creates regular demand on the sanitizer that is used to determine how much sanitizer to add in order to maintain the proper residual. If the usage pattern increases dramatically with invited guests, the amount and frequency of sanitizer required increases dramatically.

MANUAL CHLORINE (SODIUM DICHLOR)

Watkins Wellness recommends the use of **FRESHWATER** Concentrated Chlorinating Granules (sodium dichlor) for sanitizing the water. Sodium dichlor is preferred because it is totally soluble, dissolves quickly, and is nearly pH neutral. The recommended Free Available Chlorine (FAC), the amount of available chlorine to sanitize the spa, 3.0-5.0 ppm.

If the FAC is too low: Increase the FAC by adding granulated sodium dichlor.

If the FAC is too high: Allow time to pass and the FAC level will naturally drop over time.

If the spa smells of chlorine: super chlorinate or shock the spa. FAC chlorine does not have an odor whereas combined spent chlorine (chloramines) has a strong chlorine odor that can be eliminated by shocking the water.

IMPORTANT: There are several forms of stabilized chlorine available for use in spas and swimming pools. It is extremely important to choose one specifically designed for spas. Use of an incorrect product such as tri-chlor which has a very low pH (2.6) and dissolves too quickly in hot water, results in extremely high levels of chlorine that **WILL** cause damage to your spa. Use of compressed bromine or unapproved sanitizer **WILL** damage your spa and is specifically not covered under the terms of the limited warranty.

PERFORMING SUPER CHLORINATION/ NON-CHLORINE SHOCK TREATMENT

A weekly or monthly super chlorination (1.5 tsp dichlor/250 gal) or shock (4tbsp mps/250 gal (950 liters)) may be required of your chosen sanitation program. Increasing chlorine to 5 ppm for 24-48 hours removes excess waste and chloramines from the water. Sodium dichlor is 6x stronger than MPS and may be a more appropriate for those users that experience heavy bather load conditions. Operate all jets and leave the cover open for a minimum of 20 minutes to allow the oxidizer gas to vent to prevent damage and discoloration to the cover and pillows after administering a super chlorination or shock to your spa. This type of damage is considered chemical abuse and is not covered under the terms of the limited warranty.

IMPORTANT: Always allow the Free Available Chlorine to fall below 5 ppm before using your spa.

⚠ DANGER: Never leave an open spa unattended, especially if there are children present!

FRESHWATER SALT SYSTEM (OPTIONAL)

The **FRESHWATER** Salt System converts water and sodium chloride salt into chlorine sanitizer. The **FRESHWATER** Salt System is compatible with chlorine based systems and chemicals. Although the system is reduced maintenance, it is not automatic. It is important that the user regularly tests and balances the water. A calcium hardness between **25 - 75 ppm** is recommended to extend the life of the hardware. Consult the **FRESHWATER** Salt System manual for additional instructions.

ADDITIONAL FRESHWATER WATER CARE PRODUCTS

- **FRESHWATER CLEAN SCREEN** Pre-filter
- **FRESHWATER** Concentrated Chlorinating Granules
- **FRESHWATER** Monopersulfate (MPS), Chlorine-Free Oxidizer High output ozone system
- **FRESHWATER** Mineral Spa Sanitizer (not compatible on Aventine)
- **VANISHING ACT** calcium remover

It is important to follow the recommended application and maintenance programs outlined for each product's use. If the spa is being used over an extended period of time, such as a whole afternoon or evening, additional sanitizer will be needed.

IMPORTANT: Use only granulated sodium dichlor or liquid chlorine sanitizer. Silver is not compatible with bromine and biguanides. Don't use a water clarifier. Clarifiers will cause the spa water to become cloudy.

VANISHING ACT INSTRUCTIONS



PALATINO



MARINO



VANTO



TARINO

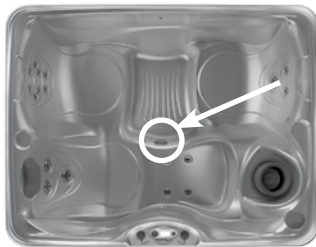

CELIO

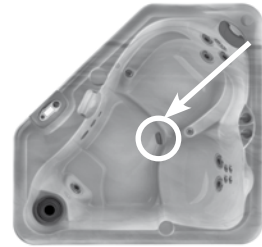

AVENTINE

Instructions for Use:

1. After Filling your hot tub, use a test strip to measure the hardness level of the water. If hardness is above **100 ppm**, use the **VANISHING ACT** calcium remover to soften the water. **Suggested Hardness Level: between 75 - 150 ppm, (it must be between 25 - 75 ppm when using the FRESHWATER Salt System in order to work).**
2. Rinse the **VANISHING ACT** calcium remover with running water until water runs clear. When placed in the hot tub, slight color transfer to the water may occur and can be easily resolved with chlorine.
3. Locate your spa above to determine which jet suction fitting the **VANISHING ACT** calcium remover will be placed up over. Use the circle to determine location.
 - a. From the control panel press the MODE (▲ or ▼) button until TOOLS is displayed.
 - Use the MODE (▲ or ▼) button to scroll through the submenus to get to the Vanishing Act Screen.
 - Press the (+) button to activate the **VANISHING ACT** which will start the low speed jet pump for 6 hours.
 - Place the **VANISHING ACT** calcium remover firmly against the associated jet suction fitting.
 - b. Test the spa water for hardness after jets shut off, which will take around 6 hours.

IMPORTANT:

- Always make sure water is balanced and properly sanitized, using the EPA approved sanitizer, before entering your hot tub.
- For maximum effectiveness, ensure that the calcium remover remains on the suction fitting while the calcium remover is in use.
- Calcium remover may not be necessary if water hardness is already in or below the suggested range.
- Multiple calcium removers may be needed if initial water hardness is above 200 ppm.

OZONE MAINTENANCE

If Reduced or no ozone bubbles are coming from the heater return (clogged ozone injector) or no ozone, clean the injector:

⚠ DANGER: Nitric acid accumulates in the air lines of the ozonator and injector, and will cause severe chemical burns if direct skin contact is made. Always wear protective gloves, glasses and clothing when working on the ozonator or injector lines. To prevent inhalation or ingestion of the nitric acid, DO NOT blow or inhale with your mouth to any of the adapters, fittings or tubing of the ozonator or injector air lines.

1. Place 16 ounces (.5 liters) of white vinegar into a cup or bucket.
2. Carefully loosen the long tubing attached to the bottom of the ozonator, located in the equipment compartment.
3. Place the end of the tubing into the vinegar, making certain that the end of the tubing sits at the bottom of the container.
4. Run the spa until all 16 ounces (.5 liters) of the vinegar are gone. This should allow an ample flow of vinegar to be run through the injector and clear the blockage.
5. Reinstall the tubing to the bottom of the ozonator.

Water chemistry damage is not covered by the warranty. The chemical levels and water quality in the spa are under your direct control.

With proper basic care, the spa will provide many years of hot water relaxation. If you are unsure about any chemical or its usage in the spa, contact your Authorized Dealer, or Watkins Wellness.

If you are unsure about any chemical or its usage in the spa, contact your Authorized Dealer, or Watkins Wellness.

DO:

- Add all chemicals slowly into the filter compartment with the jet pump operating for ten minutes.
- Use special care if using baking soda to clean either the interior or exterior plastic surfaces.
- Use granular (dichlor) or liquid (sodium hypochlorite) chlorine.

IMPORTANT: WATKINS WELLNESS DOES NOT recommend the use of any floating chemical dispenser. Damage to the spa shell or components caused by a floating chemical dispenser is specifically not covered under the terms of the limited warranty. Floating dispensers can become trapped in one area and cause an over-sanitization or release large chunks of sanitizer that very quickly chemically burn the shell and cover.

DON'T:

- Use compressed sanitizers.
- Use a floater type sanitization system as a low or no maintenance solution to your spa maintenance program.
- Use a sanitizer which is not designed for spas.
- Use swimming pool (muriatic) acid to lower pH.
- Broadcast or sprinkle the chemicals onto the water surface. This method may cause chemically-induced spa surface blistering (chemical abuse).

VACATION WATER CARE INSTRUCTIONS

If you plan to be away from home, follow these instructions to ensure that the water quality of your spa is maintained:

SHORT TIME PERIODS (3-5 DAYS)

1. Adjust the pH by following the instructions outlined in the Water Quality and Maintenance section.
2. Sanitize the water by following the shock procedures also listed in the Water Quality and Maintenance section.
3. Lock your cover in place using the coverlocks.
4. Upon your return, sanitize the water by following the shock procedures, and balance the pH.

LONG TIME PERIODS (5-14 DAYS)

Prior to leaving:

1. At least one day before you leave, set the temperature to its lowest level. This setting should represent an approximate water temperature of 80°F (27°C)

IMPORTANT: Spa water oxidizers such as sodium dichlor (chlorine) maintain their level of effectiveness substantially longer in warm water 80°F (27°C) than in hot water 101°F to 104°F (38°C - 40°C).

2. Adjust the pH as required. Sanitize the water by following the shock procedures.

Upon your return:

3. Sanitize the water by following the shock procedures. Return the set temperature to its original setting. The spa water will be safe for you to use once the Free Available Chlorine residual level has dropped below 5.0 ppm.

IMPORTANT: If you will not be using your spa for an extended period of time (in excess of 14 days) and an outside maintenance service (or neighbor) is not available to assist with the water maintenance, draining or winterizing of the spa is recommended.

SUPPLEMENTAL WATER MAINTENANCE

Proper water sanitation and mineral balance (pH control) are absolutely essential for a complete spa water maintenance program. Here are two other popular water additives that are optional:

Mineral Deposit Inhibitors

As water evaporates from your spa and new water is added, the amount of dissolved minerals will increase. (Minimize evaporation by keeping the cover on the spa whenever possible.) The spa water may eventually become "hard" (Calcium Hardness too high) enough to damage the heater by calcifying its surface. Proper pH control can minimize this.

Normal soap build-up will require water replacement regularly enough that mineral deposits normally are not a problem.

Occasionally, high iron or copper content in the water may produce green or brown stains on the spa. A stain and scale inhibitor may help to reduce these metals.

IMPORTANT: Well water may contain high concentrations of minerals. The use of a low water volume, extra-fine pore water filter (in-line pre-filter such as the **CLEAN SCREEN** pre-filter) will help to remove many of the larger particles during the filling of the spa. In-line pre-filters can be purchased at your local **CALDERA** dealer.

Foam Inhibitors

Spa water requires changing due to the buildup of soap in the water. Typically, soap will cause the spa water to foam when the jets are used. Soap is introduced into the spa water from two sources: users' bodies, which retain a soap residual after showering, and swimming apparel, which retains soap after washing.

Foam inhibitors can suppress foam, but cannot remove soap from the water. Soap is very difficult to remove from the water because soap is not oxidized by any chemical added to the spa. Only ozone can oxidize soap. Eventually the soap build-up in the water will be concentrated, resulting in an unclean feeling on the bather's skin, which is impossible to remedy. When this occurs, it's time to drain and refill the spa. Depending on the soap input, the water should last about four months before needing to be drained.

WATER TERMINOLOGY

The following chemical terms are used in this Water Quality and Maintenance section. Understanding their meaning will help you to better understand the water maintenance process.

Bromamines: Compounds formed when bromine combines with nitrogen from body oils, urine, perspiration, etc. Unlike chloramines, bromamines have no pungent odor, and are effective sanitizers.

Bromine: A halogen sanitizer (in the same chemical family as chlorine). Bromine is commonly used in stick, tablet, or granular form.

Calcium Hardness: The amount of dissolved calcium in the spa water. This should be approximately 75 -150 ppm. High levels of calcium can cause cloudy water and scaling. Low levels can cause harm to the spa equipment.

Chloramines: Compounds formed when chlorine combines with nitrogen from body oils, urine, perspiration, etc. Chloramines can cause eye irritation as well as having a strong odor. Unlike bromamines, chloramines are weaker, slower sanitizers.

Chlorine: An efficient sanitizing chemical for spas. Watkins Wellness recommends the use of sodium dichlor-type granulated chlorine. This type is preferred because it is totally soluble and nearly pH neutral.

Chlorine (or Bromine) Residual: The amount of chlorine or bromine remaining after chlorine or bromine demand has been satisfied. The residual is, therefore, the amount of sanitizer which is chemically available to kill bacteria, viruses and algae.

Corrosion: The gradual wearing away of metal and plastic spa parts, usually caused by chemical action. Generally, corrosion is caused by low pH or by water with levels of TA, CH, pH or sanitizer which are outside the recommended ranges.

Halogen: Any one of these five elements: fluorine, chlorine, bromine, iodine, and astatine.

MPS: Monopersulfate is the non-chlorine oxidizer used with the **FRESHWATER_{Ag+}** silver ion purification system. Not a sanitizer.

Nitric Acid: The formulation of nitric acid, a highly corrosive chemical, is a byproduct of the ozone generating process. Nitric acid is produced in very small quantities and is readily dissolved in the water stream with ozone.

Oxidizer: The use of an oxidizing chemical is to prevent the buildup of contaminants, maximize sanitizer efficiency, minimize combined chlorine and improve water clarity. See MPS and Ozone.

Ozone: Ozone is a powerful oxidizing agent which is produced in nature and artificially by man. Ozone forms no byproducts, oxidizes chloramines, and will not alter the water's pH.

pH: The measure of the spa water's acidity and alkalinity. The recommended pH for the spa water is 7.2 to 7.8. Below 7.0 (considered neutral), the spa water is too acidic and can damage the heating system. Above 7.8, the water is too alkaline and can result in cloudy water, and scale formation on the shell and heater.

ppm: The abbreviation of "parts per million", the standard measurement of chemical concentration in water. Identical to mg/l (milligrams per liter).

Reagent: A chemical material in liquid, powder, or tablet form for use in chemical testing.

Sanitizer: Sanitizers are added and maintained at recommended residuals to protect bathers against pathogenic organisms which can cause disease and infection in spa water.

Scale: Rough calcium-bearing deposits that can coat spa surfaces, heaters, plumbing lines, and clog filters. Generally, scaling is caused by mineral content combined with high pH. Additionally, scale forms more readily at higher water temperatures.

Sodium Hypochlorite (Liquid chlorine/bleach): Unstabilized (without cyanuric acid) chlorine in liquid form. Very effective however it has a very high pH and requires acid adjustment to maintain water parameters. Never add acid directly to chlorine.

Super-Chlorination: Also known as "shock treatment." Super-Chlorination is a process of adding significant doses of a quick dissolving sanitizer ("dichlor" is recommended) to oxidize non-filterable organic waste and to remove chloramines and bromamines.

Total Alkalinity (TA): The amount of bicarbonates, carbonates, and hydroxides present in spa water. Proper total alkalinity is important for pH control. If the TA is too high, the pH is difficult to adjust. If the TA is too low, the pH will be difficult to hold at the proper level. The desired range of TA in spa water is 40 to 120 ppm.

SPA CARE AND MAINTENANCE

Your **CALDERA** spa is manufactured from the highest quality, most durable materials available. Even so, the spa care and maintenance program you develop will ultimately determine how long your spa, and its individual components, will last. Regular maintenance and following the advice in this section will help you to protect your investment.

DRAIN & REFILL INSTRUCTIONS

IMPORTANT: It is NOT recommended to refill your spa when the ambient temperature goes below 50°F (10°C).

1. Disconnect the spa from the power supply by tripping both of the GFCI breakers located in the subpanel. Unplug power cord for 115V models.
2. Locate the drain valve for the spa (lower front of the spa) and remove the drain cap. Attach the inlet of a garden hose to the drain valve and route the outlet of the hose to an appropriate draining area. Spa water with a high sanitizer level may harm plants and grass.
3. Open the drain valve by turning the knob. The spa will drain by gravitational flow.

IMPORTANT: All **Caldera** spa models will drain to the bottom of the suction fitting, use vacuum side of shop vac to remove remaining water. Any water remaining within the plumbing or equipment after draining will only need to be removed if the spa is being winterized.

4. When empty, inspect the spa shell and clean as required. (Follow the Care of the Exterior instructions.)
5. Close the drain valve and reinstall the drain cap.
6. Install new filter or clean existing with filter cleaner.
7. Refill the spa through the filter compartment using the **CLEAN SCREEN** pre-filter.
IMPORTANT: Refill water temperature must be between 50° - 70°F (10° - 21°C) to avoid high-limit tripping.
8. Follow the Quick Start-Up instructions on page 9.

COLD WATER REFILL

- When refilling your spa if the tap water is below 50° F (10° C) the spa may go into a High Limit Protection mode (causing your spa to stop functioning). If high limit tripping does occur, the fastest way to reactivate the spa control system is to first disconnect power to the spa completely, then warm the two sensors on top of the heater and the vinyl tubing (located in the equipment compartment) with a hair dryer for approximately 10 minutes. Once you believe the sensors and heater tubing have been warmed sufficiently, reconnect power to the spa.
- Blending warm water with the cold tap water so it exceeds 50° F (10° C) during the refilling process will also achieve the same results if that is an option for you.

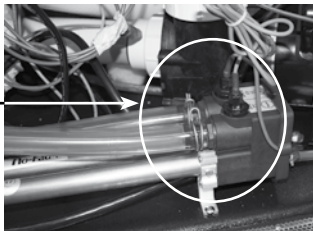

the selected temperature. The energy efficiency of the spa may also decrease during these cold periods, as the heater will cycle more frequently. As an additional precaution against partial freezing of some of the components, the equipment compartment can be insulated with an insulating kit (available from your local dealer). This insulating kit will also help to maximize the spa's energy efficiency.

NOTE: When warmer weather returns (approx. 60-70°F (16°-21°C)), the insulating kit must be removed to prevent overheating of the jet pump.

WINTERIZING YOUR SPA

If you leave the spa unused for a long period of time in severely cold weather, you should drain the spa and winterize it to avoid accidental freezing due to a power or equipment failure.

⚠ DANGER: Use only Propylene Glycol as your anti-freeze (available at most RV or marine supply stores). This is non-toxic. Never use an automobile anti-freeze (Ethylene Glycol) since it is toxic!

⚠ WARNING: Failure to follow these instructions correctly can lead to freeze damage not covered by warranty. It is strongly recommended that you contact your local **CALDERA** dealer to perform this service

1. Drain your spa following the Drain & Refill Instructions. Open waterfall valve.
2. Remove the filter cartridge, clean and store in a dry place.
IMPORTANT: These additional instructions must be utilized when draining and winterizing your spa in climates where the temperature falls below 32°F (0°C). A 5 gallon (19 liters) combination (vacuum/blower) wet/dry shop vac must be used to effectively remove water that is trapped inside the plumbing lines.
3. Attach the vacuum hose to the vacuum side of the shop vac. Vacuum all openings and orifices as follows:
 - a. Jet openings: start with the jets at the top and move downward (if suction is coming from another jet, block off the other jet using a large rag this will help pull out the water that is trapped deeper inside the main line).
 - b. Filter suction fittings and filter compartment.
 - c. Main drain outlet (it may be necessary to cover the drain grate tightly with a rag when vacuuming the main drain to ensure water is drawn completely from the internal plumbing system).
4. Thoroughly dry the spa shell with a clean towel.
5. Replace the main drain cap.
CAUTION: Use only Propylene Glycol as your anti-freeze. This is non-toxic. Never use an automobile anti-freeze (Ethylene Glycol) since it is toxic!
6. Using a long-extension funnel, pour anti-freeze into all standpipes, filter suction fittings, jet orifices and water feature orifices. Add enough anti-freeze to ensure adequate protection – in many cases, you will see the liquid in the orifice, or coming out of another location.
7. Close the spa cover and fasten the cover tie downs. Cover the spa cover with two pieces of plywood to evenly distribute the weight of snow and ice. Secure a plastic sheet, or tarp, over the spa cover and plywood.
8. Replace the equipment access door, if removed.

PREVENTION OF FREEZING

Your spa has been designed and engineered for year-round use in any climate. In some areas, extremely cold temperatures below 10°F (-12°C) combined with strong wind, may cause partial freezing of the jet pump, even though the water inside the spa remains at

OPENING INSTRUCTIONS:

1. Remove plywood and plastic sheet. Open the spa cover by unfastening the cover tie downs.
2. Follow the Start-up and Refill Procedures in the Operating Instructions section of the Owner's Manual. Do not install filters to prevent them from exposure to the anti-freeze.
3. As part of this process, superchlorinate the spa water by adding three teaspoons of chlorine (sodium dichlor) per 250 gallons (950 liters) of spa water into the filter compartment. This is twice the normal amount of chlorine needed for superchlorination. This extra amount of chlorine is needed to destroy the anti-freeze.

NOTE: A defoamer may be needed to decrease the amount of foam caused by the anti-freeze.

4. Drain your spa to ensure removal of anti-freeze. Do not drain water on grass or plants due to excessive chlorine level.
5. After the spa has completely drained, re-install your filter and follow the Start-up and Refill Procedures in the Operating Instructions section of the Owner's Manual.

IMPORTANT: Always keep spa covered when not in use, whether it is empty or full.

FILTER SYSTEM

The filter lid on the spa is NOT designed to support heavy weight loads and should not be used as a seat. In extreme cases, the lid could crack and break. This occurrence is considered abuse and is not covered under the warranty.

CALDERA spas are equipped with one filter cartridge, sized to meet the needs of the jet pump system.

At least once a week, check and clean the skimmer basket and weir to ensure proper filter flow. Remove leaves, foreign matter, and debris. It is very important to keep your spa filter cartridge clean and free of particles to ensure proper water flow. A clean filter permits the hydrotherapy system to function properly and also allows more efficient filter cycles. Depending on how frequently your spa is used, we recommend cleaning the spa filter cartridge every four weeks. If this is not done, the filter may clog and restrict water flow, which causes improper filtration and poor jet performance.

⚠ WARNING: To reduce the risk of injury to persons using the spa, DO NOT remove the suction fittings (filter standpipes) located in the filter compartment and do not sit on the filter lid, in extreme cases the lid could crack and break. This occurrence is considered abuse and is not covered under warranty.

FILTER CARTRIDGES REMOVAL & CLEANING (ALL MODELS EXCEPT AVENTINE)

1. Disconnect the spa from the power supply by turning the power to the spa OFF.
2. Remove any floating items from within the filter compartment.
3. Turn the filter retainer handle (located on the top of the filter cartridge) counterclockwise until the retainer can be removed from the filter standpipe.
4. Remove the filter retainer, cover and cartridge.

SERVICE NOTE: Never remove the filter standpipe when debris is present in the filter compartment. Debris may find its way into the internal plumbing which may result in blockage. NEVER REMOVE SUCTION FITTINGS!

5. Always clean the filter using a filter degreaser, such as Filter Cleaner, to remove mineral and oil build-up. Simply soak the filter in the degreaser according to the package directions, then place the filter on a clean surface and spray until clean using a garden hose. It may be necessary to rotate the filter

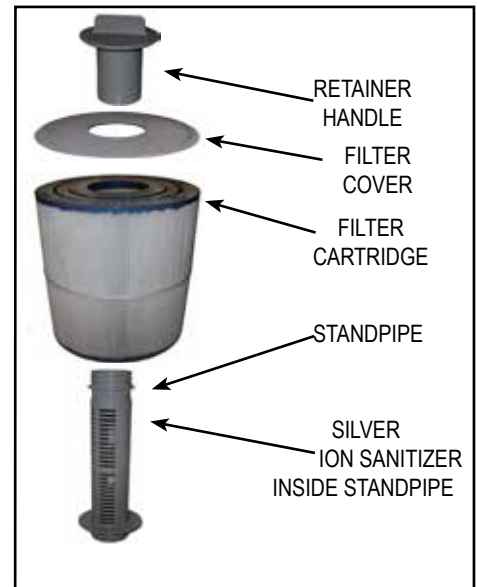

- while spraying to remove any debris lodged between the filter pleats.
6. To reinstall the filter cartridge, reverse the order of steps in which it was removed. Do not overtighten.

⚠ WARNING: Do not use the spa with the filter cartridge, or filter standpipe removed!

FILTER CARTRIDGES REMOVAL & CLEANING FOR AVENTINE MODEL

1. Turn the power to the spa OFF, then proceed as follows:
2. Push down slightly and turn filter basket counterclockwise to unlock, then pull the basket and weir out.
3. Carefully pull up the filter cartridge and bring it out of the spa.



4. Rinse cartridge using a garden hose. Rotate and separate filter pleats while spraying water to remove all debris possible. Let the filter dry and then look for calcium deposits (scaling) or an oil film. If you find these, you will need to deep clean your filter cartridge with a "spa filter cleaning" solution to break down and remove mineral deposits and oils.

NOTE: This model (only) is NOT able to use the Silver ion sanitizer.

5. Install filter then replace basket and weir by inserting and rotating clockwise to lock into position.

CARE OF THE SPA PILLOWS

The spa pillows will provide years of comfort if treated with care. They have been positioned above the water level to minimize the bleaching effects of chlorinated water, and other spa water chemicals. To extend their life, whenever the spa shell is being cleaned, the spa pillows should be removed and cleaned. Body oils can be removed with a mild soap and water solution. ALWAYS rinse off the spa pillows thoroughly to remove any soap residue. If the spa is not going to be used for a long period of time (that is during a vacation, or if the spa is winterized), or when the spa water is being super-chlorinated, the spa pillows should be removed until the next spa use.

To remove and replace the spa pillows:

1. Carefully lift one end of the pillow away from the spa shell.
2. Continue lifting one end until all pillow retainers are released from the pillow.
IMPORTANT: Just pulling the pillow straight up and out of the shell recess will eventually damage the pillow. This abuse is not covered under warranty.
3. To reinstall the spa pillow, carefully bend the pillow slightly to allow one of the pillow retainers to slip into the recess in the back of the pillow.
4. Keeping the pillow slightly bent, slide the other pillow retainer into the recess in the back of the pillow.
5. After all the pillow retainers are in place, press the pillow down into the recess in the spa shell.

CARE OF THE INTERIOR

SPA SHELL

Your **CALDERA** spa has an acrylic shell. Stains and dirt generally will not adhere to your spa's surface. A soft rag or a nylon scrubber should easily remove most dirt. Most household chemicals are harmful to your spa's shell (see below for detailed information on cleaning agents). Always rinse off any spa shell cleaning agent with fresh water.

IMPORTANT:

1. The following products are the **ONLY** approved cleaning agents for your **CALDERA** spa shell: plain water, **CALDERA** Spa Shine or Soft Scrub®. The use of alcohol or any other household cleaner other than those listed to clean the spa shell surface is **NOT** recommended. **DO NOT** use any cleaning products containing abrasives or solvents since they may damage the shell surface, specifically: Simple Green®, Windex® or Spa Mitt. **NEVER USE HARSH CHEMICALS!** Damage to the shell by use of harsh chemicals is not covered under the warranty. Always rinse off any spa shell cleaning agent with fresh water.
2. Iron and copper in the water can stain the spa shell if allowed to go unchecked. Ask your **CALDERA** dealer about a Stain and Scale Inhibitor to use if your spa has a high concentration of dissolved minerals. (Watkins Wellness recommends Stain & Scale Defense.)
3. Keep all cleaners out of the reach of children and use care when applying.

CARE OF THE ECOTECH CABINET

The **ECOTECH** cabinet consists of rigid polymers that combine the durability of plastic, with the beauty of wood.

Cleaning your **ECOTECH** cabinet is as easy as spraying the cabinet with a mild soap and water solution to remove any stains and residue.

COVER CARE

The cover is made with a solution dyed polyester fabric and is an attractive, durable foam insulation product. Monthly cleaning is recommended to maintain its beauty and a longer fabric life.

To clean and condition the polyester cover:

1. Remove and gently lean against a wall or fence. If a cover lifter has been installed keep cover closed and make sure all seams are closed to prevent any soap from entering the spa.
2. With a garden hose, spray the cover to loosen and rinse away dirt or debris.
3. Add four tablespoons of mild soap or mild dishwashing liquid with one gallon (4 liters) of lukewarm water. Clean using a soft bristle brush. Rinse thoroughly with cold water and air dry. **IMPORTANT:** Do not let the polyester dry with a soap film on it before it can be rinsed clean.
4. Scrub the cover's perimeter and side flaps. Rinse clean with water.
5. Rinse off the underside of the cover with water only (use no soap), and wipe it clean with a dry rag.

DO:

- Remove snow buildup to avoid breakage of the foam core from the additional weight of the snow.
- Lock cover lock straps to secure the cover when the spa is not in use.

DON'T:

- Drag or lift the spa cover using either the flaps, or the cover lock straps.
- Walk, stand, or sit on the cover.
- Place any metal or heat transferring object on the cover or place any type of plastic tarp or drop cloth over the cover as this may result in a melted foam core, which would not be covered under the warranty.
- Use any lifting mechanisms, chemicals, or cleaners except those recommended by Watkins Wellness, or its Authorized Sales and Service Dealer.

SERVICE INFORMATION

GENERAL INFORMATION

Your **CALDERA** spa has been designed to provide years of trouble-free use. As with any appliance, problems may occasionally occur that require the expertise of a qualified service person. Though such simple repairs as resetting a GFCI switch or breaker, high limit thermostat, or pressure switch, or replacing a light bulb may not require a service call, they may indicate that a more serious condition exists. These conditions may require an experienced service person. Before calling for service, please refer to the Troubleshooting Guide.

NOTE: Always retain your original sales receipt for future reference.

GFCI AND HIGH LIMIT THERMOSTAT

If your spa fails to operate at any time, the following items should be checked:

1. Check the power supply to the spa.
2. Check the GFCI (located at the end of the cord in standard models or in the electrical subpanel in 30 or 50 amp converted models) and see if it has tripped. If a GFCI has tripped, reset it. If it will not reset, this may be an indication of a ground fault (short circuit) within the electrical components. Contact an Authorized Service Technician for a complete diagnosis.
3. If, upon checking the GFCI you find it has not tripped, check the house breaker panel and ensure the main breaker for the electrical circuit supplying the spa has not tripped. If it has, this is an indication that either the circuit was overloaded or a ground fault exists between the breaker panel and the spa receptacle. Contact a qualified electrician.
4. If, upon checking the main house breaker, you find no failures, the heater high-limit thermostat should be checked. Tripping of the heater high-limit thermostat is normally a result of one or a combination of any of these problems: 1) blockage within the system plumbing, 2) switch malfunction in the heater circuit, or 3) the low speed mode of the jet pump is not functioning.
5. If the heater high-limit has tripped, the control panel display will display - - - -. Reset the heater high-limit by allowing the water to cool and disconnecting power to the spa for at least thirty seconds. If the heater high-limit continues to trip, contact an Authorized Service Technician for a complete diagnosis.

If the spa does not function and the GFCI or GFCI breaker and heater high-limit have not tripped, then the problem should be referred to an Authorized Service Technician. Refer to the Troubleshooting Guide for additional service information.

HEATER AND INTEGRATED PRESSURE SWITCH

Watkins Wellness unconditionally warrants the heater against any failure that would require replacement. This warranty's duration is equal to the time period identified in the Heater Warranty. This warranty defines unconditional as warranty coverage without exception provided that the component has failed to operate properly within the spa's system. This means that conditions that would normally invalidate the limited warranty, such as water chemistry damage, do not apply to the heater.

It is important to note that the heater is protected by both the heater high limit thermostat circuit and the integrated pressure switch. The causes of heater high limit tripping are discussed in the previous section.

If the spa is not heating, the red and green lights are blinking, but the pump and light are operating, then the pressure switch may be open. Opening of the pressure switch is normally a result of one or a combination of these problems:

1. A clogged filter cartridge
2. Blockage within the system plumbing
3. Power was not disconnected to the spa before it was drained
4. An air lock in the plumbing lines
5. Circulation pump not properly working

Once the problem has been identified and corrected the pressure switch will close which will energize the heater.

CIRCULATION PUMP AND CIRCULATION PUMP THERMAL CUT-OFF

The circulation pump is a dedicated, water cooled, energy efficient, quiet pump that provides continuous filtration for the spa. Since the pump is water cooled, it is equipped with a thermal cut-off to prevent the pump from being damaged by running hot when water is not present.

Reset the circulation pump's thermal cut-off by disconnecting power to the spa and allowing the pump to cool.

Tripping of the thermal cut-off is normally the result of one or a combination of these problems: 1) clogged filter cartridge(s), 2) blockage within the system plumbing, 3) power was not disconnected to the spa before it was drained, or 4) an air lock in the plumbing lines. Once the problem has been identified and corrected the pump thermal cut-off will be able to be reset which will allow it to operate normally.

MISCELLANEOUS SERVICE INFORMATION

The jet pump is equipped with an overload cut-off switch, which is designed to protect the pump from overheating. If the pump shuts itself off in a new spa, it is usually the result of one, or a combination of, the following factors:

High Temperature: During the summer months, especially in warmer climates, the ambient temperature contributes to excessively high temperatures within the equipment compartment.

Improper House Wiring: If the spa is not connected to a dedicated circuit, or is connected to an extension cord, or the house wiring is undersized, the pump may starve for voltage and therefore may draw more amperage and generate excessive heat. This will often cause the circuit breaker to trip repeatedly.

IMPORTANT:

1. If the pump is shutting down due to excessive heat, make sure the equipment compartment has adequate ventilation. The air gap at the bottom and the jet pump vent at the bottom left corner must not be blocked. Should your jet pump continue to shut off after short periods of use, contact a qualified service technician.
2. The **VACANZA** spa is equipped with a safety suction spring valve which will break the prime of the jet pump if both suction fittings are obstructed.

ACTS INVALIDATING WARRANTY

The limited warranty is void if the **CALDERA** Spa has been subjected to alteration, misuse or abuse, or if any repairs on the spa are attempted by anyone other than an authorized representative of Watkins Wellness. Alteration is defined as any component or plumbing change, electrical conversion, or the addition of any non-approved sanitation, or water purification device, or heating system which contributes to a component failure, unit failure, or unsafe operating condition. Misuse and abuse shall include any operation of the spa other than in accordance with Watkins Wellness printed instructions, or use of the spa in an application for which it is not designed; specifically: use of the spa in a non-residential application; damage caused by operation* of the spa at water temperatures outside the range of 35°F and 120°F (2°C and 49°C); damage caused by a dirty, clogged, or calcified filter cartridge; damage to the spa surface caused by the use of Tri-Chloro Chlorine, BCDMH, chemical tablets in a floater, acid, or any other spa chemicals, or spa surface cleaners which are not recommended by Watkins Wellness; damage caused by allowing undissolved spa sanitizing chemicals to lie on the spa surface (no spa surface material can withstand this kind of abuse); damage to components or spa surface caused by improper water chemistry maintenance; and damage to the spa surface caused by leaving the spa uncovered while empty of water and in direct exposure to sunlight (this may cause solar heating distress in warm weather regions). These are considered abuses and may invalidate this warranty.

*Operation of the spa **DOES NOT** mean "use" of the spa! Watkins Wellness does not recommend using the spa if the water temperature is above or below the spa's control panel temperature range.

DISCLAIMERS

Watkins Wellness shall not be liable for loss of use of the **CALDERA** spa or other incidental or consequential costs, expenses, or damages, which may include but are not limited to, the removal of a permanent deck or other custom fixture. Any implied warranty shall have a duration equal to the duration of the applicable warranty stated above. Under no circumstances shall Watkins Wellness, or any of its representatives, be held liable for injury to any person, or damage to any property, however arising.

WATKINS CUSTOMER SERVICE

If you have any questions about any aspect of your **VACANZA** series spa set-up, operation or maintenance that have not been answered by this manual, consult your **CALDERA** dealer.

Watkins Manufacturing Corporation can be reached at: 800-669-1881 (Extension 8432), Monday through Friday, 8 am to 5-pm Pacific Standard Time (PST), or e-mail at customerservice@watkinsmfg.com.

TROUBLESHOOTING

Should you experience any problem, do not hesitate to contact your authorized **CALDERA** dealer. Here are some tips to help you to diagnose and rectify some more common sources of trouble yourself, if you choose to do so.

GENERAL OPERATION TROUBLESHOOTING GUIDE		
Problem	Probable causes	Solutions
Entire spa is inoperative.	<ul style="list-style-type: none"> Power failure / not plugged in GFCI tripped 	<ul style="list-style-type: none"> Check power source Reset GFCI; call for service if it will not reset.
Spa does not heat; jets and light operate. Display shows "====" POWER & READY icon flashes	<ul style="list-style-type: none"> Pressure switch is open and should be closed Pressure switch senses flow through heater even though the jet pump is off 	<ul style="list-style-type: none"> Check for clogged filter. The pressure switch will reset when the flow of water through the heater has been restored. Call for service if the pressure switch trips frequently. Contact an Authorized Service Technician
READY icon flashes	<ul style="list-style-type: none"> Control Sensor open or shorted 	<ul style="list-style-type: none"> Contact an Authorized Service Technician
Spa does not heat; jets and light operate. Display shows "====" POWER & READY icon flashes	<ul style="list-style-type: none"> Pressure switch is closed and should be open 	<ul style="list-style-type: none"> Contact an Authorized Service Technician
Jets weak or surging	<ul style="list-style-type: none"> Spa water level too low Filters clogged / suction screens clogged Jet nozzles closed / Air valve closed 	<ul style="list-style-type: none"> Add water Clean filters / Clean suction screens Open jet nozzles / Open air valve
Light inoperative	<ul style="list-style-type: none"> Bad connection 	<ul style="list-style-type: none"> Contact an Authorized Service Technician
Display shows "----" (Entire spa is inoperative.) POWER icon flashes	<ul style="list-style-type: none"> Heater high limit thermostat tripped 	<ul style="list-style-type: none"> Disconnect power to the spa for at least thirty seconds to reset the heater high-limit. If tripping continues, clean the filter, then if tripping still occurs, call for service.
After filling or refilling the spa: a jet pump is operating, but water is not flowing from any of its jets.	<ul style="list-style-type: none"> Pump is not properly primed. 	<ol style="list-style-type: none"> Turn off power to the spa at the breaker and remove the equipment compartment door Loosen the union on the top of the pump(s) (as seen on page 10) to allow the air to escape, the hand-tighten the union(s). Turn power back on, activate the pump and check to make sure union is tight enough to keep it from leaking. Re-install pump and equipment doors. OR: Remove and reinstall the SALT cap.

DOOR PANEL INSTRUCTIONS

DOOR PANEL REMOVAL

The illustrations are to be used as a reference only (your spa may look slightly different).

1

Locate and remove the two screws on the bottom of each corner on the front panel (same side as the Control Panel).



2

Locate notch below panel on one side and center. Placing fingers inside notches, pull panel slightly away from spa only on side (not center).

Locate notch on other side of panel and place fingers inside the notch and center notch. Pull panel away from spa, lower panel and store in a cool and shaded place.

NOTE: It may be possible when pulling out the first clip to pull the panel out too far releasing the second clip.



DOOR PANEL REPLACEMENT

1

In order to replace the panel, the illustration to the right shows how the panel is held in place.

- The 4 plastic clips attached to the top back side of the door panel slide behind the 4 plastic clips attached to the spa.
- The 2 metal clips on the bottom of the door snap into the 2 metal clips attached to the bottom of the spa.

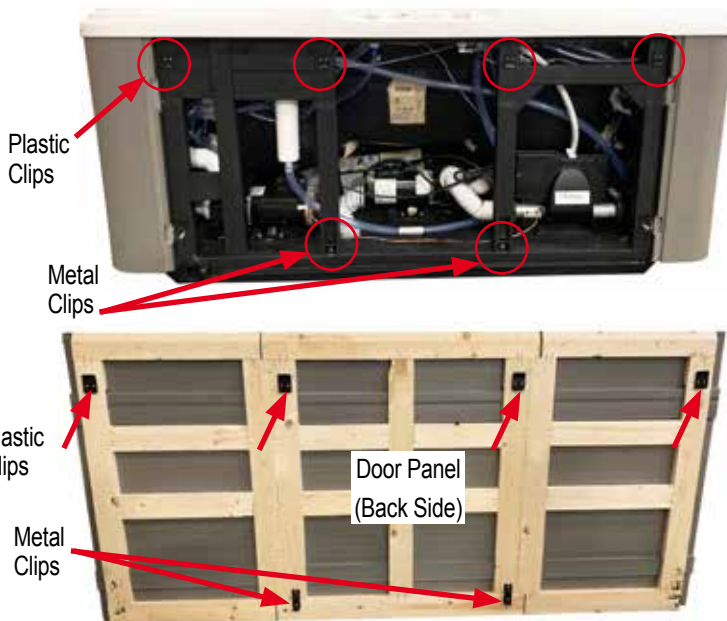

Bar top



2

Place door panel in position as illustrated to the left.

- Raise door panel from bottom making sure all 4 door panel plastic clips are behind the 4 spa plastic clips, this requires the door panel to be behind the bar top.
- Using both hands, push in the area where the metal clips are located to snap the door panel metal clips into position.
- Replace the 2 screws that were removed in step 1 of the Door Panel Removal section.

VACANZA SERIES SPA SPECIFICATIONS

	Footprint dimensions	Height	Effective filter area	Heater (Watts)	Water capacity	Dry weight	Filled weight*	Dead weight*	Electrical requirements
PALATINO (Model PLT) 6 Person	7'5" x 7'5" 2.3 m x 2.3 m	38.5" 98 cm	65 ft ²	4,000	400 gal 1,525 lit	910 lbs 415 kg	5,295 lbs 2,420 kg	125 lbs/ft ² 610 kg/m ²	230 volt, 20A & 30A Single phase GFCI circuits
MARINO (Model MRN) 6 Person	7'0" x 7'0" 2.1 m x 2.1 m	36" 91 cm	65 ft ²	4,000	360 gal 1,375 lit	835 lbs 380 kg	4,885 lbs 2,235 kg	130 lbs/ft ² 635 kg/m ²	230 volt, 20A & 30A Single phase GFCI circuits
VANTO (Model VNT) 7 Person	7'0" x 7'0" 2.1 m x 2.1 m	36" 91 cm	65 ft ²	4,000	375 gal 1,425 lit	845 lbs 385 kg	5,200 lbs 2370 kg	140 lbs/ft ² 685 kg/m ²	230 volt, 20A & 30A Single phase GFCI circuits
TARINO (Model TAR) 5 Person	6'10" x 6'10" 2.1 m x 2.1 m	33" 84 cm	30 ft ²	1,000 or 4,000	310 gal 1,175 lit	730 lbs 330 kg	4,190 lbs 1,905 kg	120 lbs/ft ² 585 kg/m ²	115 volt, 20A dedicated GFCI or 230 volt, 20A & 30A Single phase GFCI circuits
CELIO (Model CEL) 3 Person	7'0" x 5'5" 2.1 m x 1.7 m	29" 76 cm	30 ft ²	1,000 or 4,000	215 gal 825 lit	635 lbs 290 kg	2,955 lbs 1,355 kg	105 lbs/ft ² 515 kg/m ²	115 volt, 20A dedicated GFCI or 230 volt, 20A & 30A Single phase GFCI circuits
AVENTINE (Model AVH) 2 Person	5'4" x 5'4" 1.6 m x 1.6 m	29" 74 cm	35 ft ²	1,000 or 4,000	150 gal 575 lit	440 lbs 200 kg	2,060 lbs 935 kg	120 lbs/ft ² 585 kg/m ²	115 volt, 20A dedicated GFCI or 230 volt, 20A & 30A Single phase GFCI circuits

CAUTION: Watkins Wellness suggests a structural engineer or contractor be consulted before the spa is placed on an elevated deck.

* **NOTE:** The "Filled weight" and "Dead weight" of the spa includes the weight of the occupants (assuming an average occupant weight of 175 lbs (80 kg)).



Watkins Wellness®

Feel good. Live well.

©2025 Watkins Wellness. Caldera Spas, Vacanza, Palatino, Marino, Tarino, Vanto, Celio, Aventine, EcoTech, Mystique, Euro-Pulse, AdaptaFlo, AdaptaSsage, and The Home Relaxation Specialists are trademarks of Watkins Wellness. BaquaSpa is a trademark of Arch UK Biocides, Limited Inc. Simple Green, Windex, Brilliance and Soft Scrub also have registered trademarks owned by various companies.

Vista, California
USA

calderaspas.com



303765.25

303765.25 C (03/25)